



:

,

1. . . , . . , . . “ ”. . . 2008. -408 .
2. . . , . . “ ” . . . 2014. -233 .
3. . . , . . “ ”. . . 1996. -328 .
4. . . , . . “ ”. . . 2006. -344 .
5. . . , . . , 1960 .-604 .
6. . . , . . , 1981 . - 376 .

1. . . , . . , 1991. - 319 .
2. . I-IV .



1. <http://tiame.uz/uz/page/ilmiy-jurnallar> ( . . . ) .
2. [http://qxjurnal.uz/load/jurnal\\_2017/agro\\_ilm\\_2017](http://qxjurnal.uz/load/jurnal_2017/agro_ilm_2017) ( . . . ) .
3. [https://elibrary.ru/title\\_about.asp?id=54940](https://elibrary.ru/title_about.asp?id=54940) ( . . . ) .

“ . , ” , .

I. (10 ).	1.1. . 1.2. , , 1.3. , 1.4 .	,
II. (55 ).	2.1. , 2.2. Power point 2.3. ; .	, ,
III. (15 ).	3.1. , , , 3.2. .	, , .

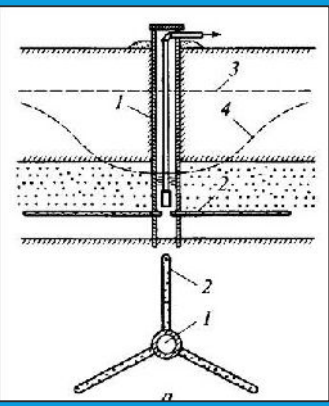
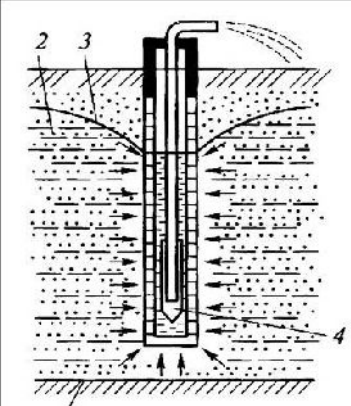

C

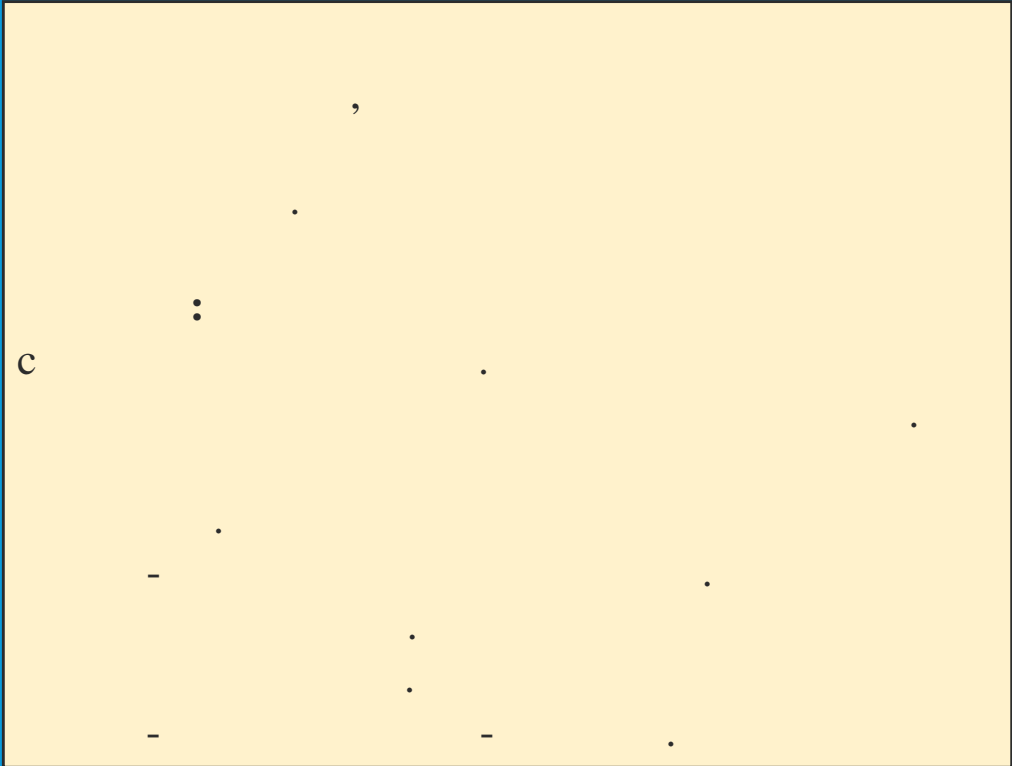

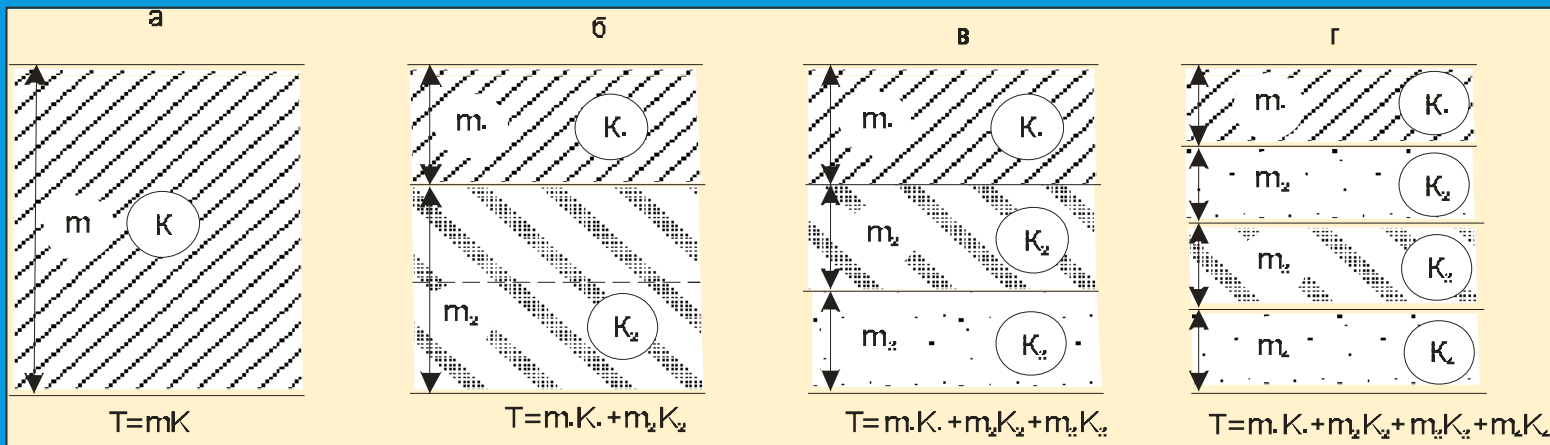

) 2      3      : ) 1      1      ; ) 1      2      3      ;  
 ; ) 2      4

			ётиқ	қурама	тик
1	1	$H_{ср}$ , м	3,0	3,0-5,0	5,0
		$m$ , м		-	20,0
		$K$ , м/кун	0,1	-	5,0
		$T$ , м <sup>2</sup> /кун	1,0-5,0	-	100
	2	$m_1$ , м	5,0-15,0	5,0-15,0	20,0
		$K$ , м/кун	0,1	0,1	5,0
		$T_2$ , м <sup>2</sup> /кун	20,0	20-100	100
		$q_{бс}$ м/кун	0,1	0,1-0,2	0,2
2	3 (4)	$m_1$ , м	5,0-15,0	5,0-15,0	20,0
		$K$ , м/кун	0,1	0,1	5,0
		$T_1$ , м <sup>2</sup> /кун	5,0-20,0	5,0-20,0	100
		$T_2$ , м <sup>2</sup> /кун	20,0	20-100	100

3  
3-5  
5  
20<sup>2/</sup>  
20-100<sup>2/</sup>  
100<sup>2/</sup>  
:

Diagram illustrating the natural development of a river channel (Табий зовурланиш).

The diagram shows a plan view of a river channel with a meandering course. A dashed line indicates the original straight channel, while a solid line shows the meandering path. Arrows indicate the direction of flow. A cross-section of the channel is shown to the right, illustrating the formation of a meander neck and the process of channel migration.

The cross-section shows a riverbed with a central channel and a meander neck. The channel is shown migrating towards the outer bank of the meander. The diagram illustrates the process of channel migration and the formation of a meander neck.

The diagram is divided into two main sections:

- Left Section:** A large yellow rectangular area containing a diagram of a river channel with a meandering course. A dashed line indicates the original straight channel, while a solid line shows the meandering path. Arrows indicate the direction of flow. A cross-section of the channel is shown to the right, illustrating the formation of a meander neck and the process of channel migration.
- Right Section:** A smaller yellow rectangular area containing a diagram of a river channel with a meandering course. A dashed line indicates the original straight channel, while a solid line shows the meandering path. Arrows indicate the direction of flow. A cross-section of the channel is shown to the right, illustrating the formation of a meander neck and the process of channel migration.





Blank yellow area for notes.

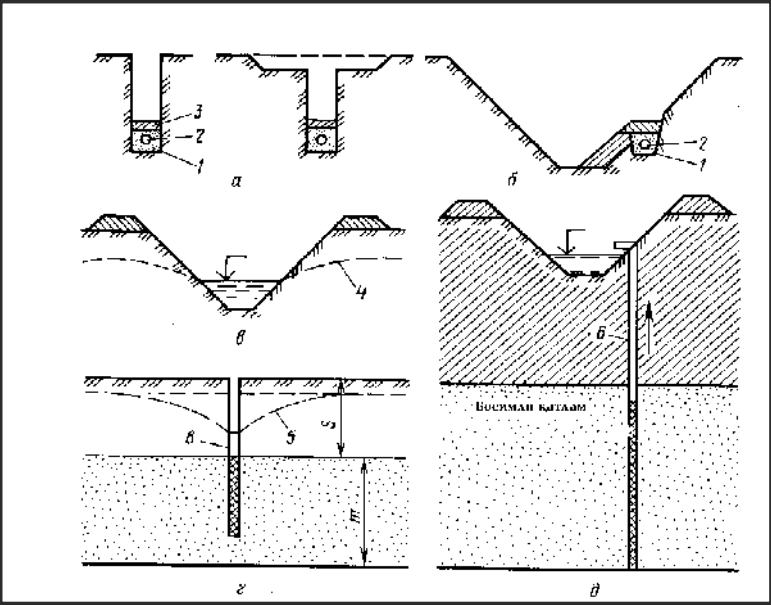

Technical diagrams illustrating well construction and components:

- a) Cross-section of a well with casing and a screen.
- b) Cross-section of a well with casing and a screen, showing a different configuration.
- c) Cross-section of a well with a gravel filter and a gravel layer.
- d) Cross-section of a well with a gravel filter and a gravel layer, labeled "БУСМАН КИТАМ".

Blank yellow area for notes.

<p style="color: red; margin: 0;">1) ;</p> <p style="color: red; margin: 0;">2) ;</p> <p style="color: red; margin: 0;">3) ;</p> <p style="color: red; margin: 0;">4) ;</p>	
	<p style="margin: 0;">; 2- ; 3,4,5- : 1-</p> <p style="margin: 0;">; 6-</p>



бу ерда  $M$  - мавсумда шўр ювиш учун берилган сув хажми,  $m^3/га$ :

-

1,0-1,2 , 20-50

«V »

$$V = \frac{M}{10000}, \quad /$$

$M$  - ,  $^3/$  ;  
 $T$  - , .

(V )

,  $V < V$  ,

(V )

$V > V$  ,

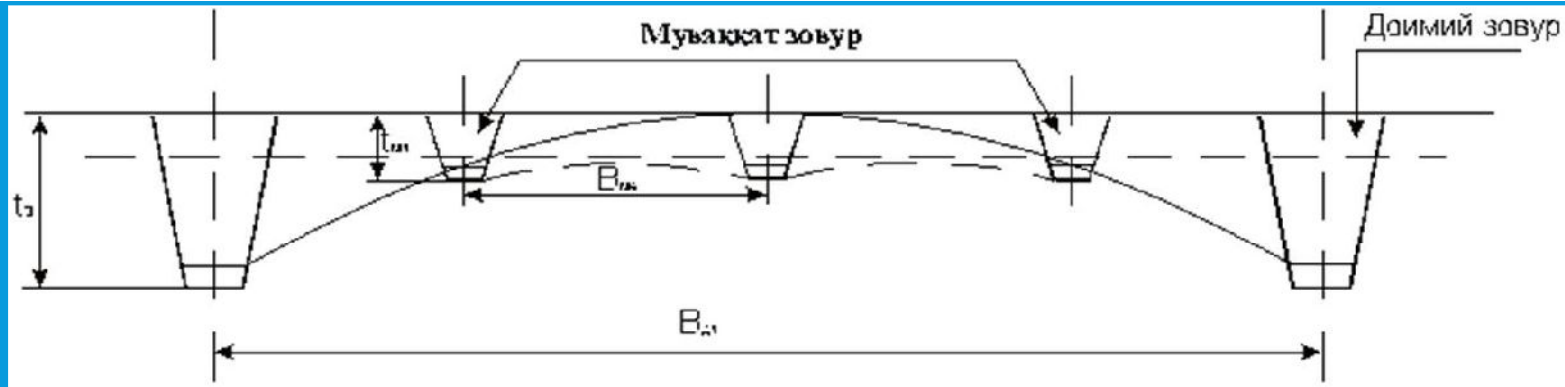

: K -

; -

$$= \frac{\pi \cdot \dots}{V \left( l \frac{B}{d} - l \right)},$$

( = h = 1.0-1.2 . ) ; d -

( d = 0.5b + h ) . ; b -



1. ?

2.

3. ?

4. .

5. ?

6. ?

7. ?

8. ?

9. ?

10. ?

11. , , .

12. .

13. .

14. .

15. .

16. .

17. .

18. .



