

AutoCAD ни ишга туширувчи белги

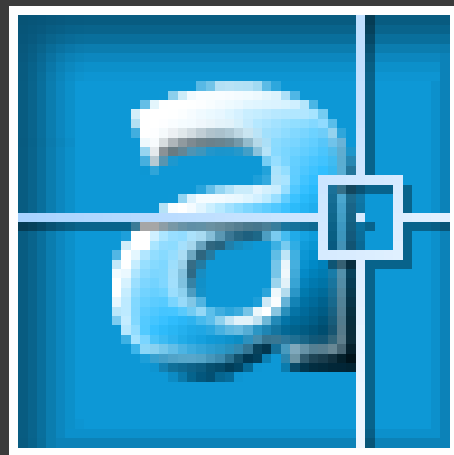

Toolbar with icons for file operations, editing, and viewing. Layer selection dropdowns are set to 'ByLayer'. A status bar at the bottom left shows '0'.

Vertical toolbar containing various drawing and editing tools such as lines, arcs, circles, and text.

New Features Workshop

The New Features Workshop is a series of interactive animations, tutorials, and short descriptions designed to help you learn the new features.

Would you like to view the New Features Workshop now?

- Yes
- Maybe later
- No, don't show me this again

You can also access the New Features Workshop from the Help menu.



OK

autodesk

AutoCAD
куйидагиларда
Н ТАШКИЛ
ТОПГАН

menu bar
Standard toolbar

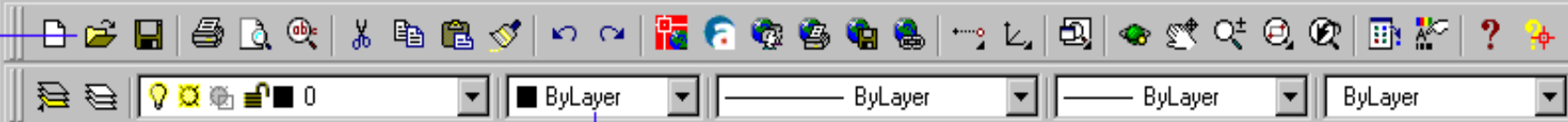

Draw toolbar
Modify toolbar

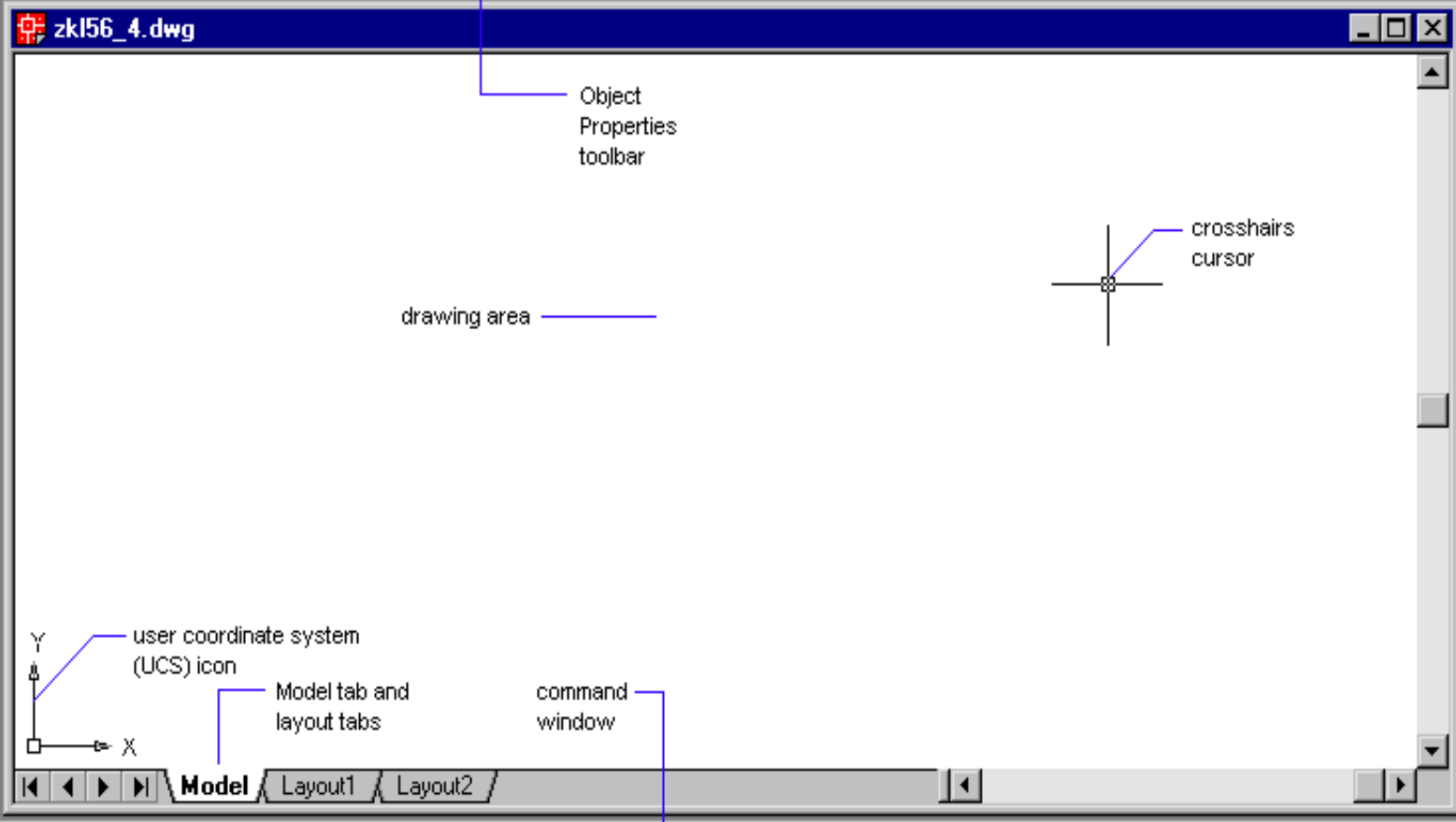

command line

Regenerating model.
AutoCAD menu utilities loaded.
Command:

14.9924, 6.1042, 0.0000 SNAP GRID ORTHO POLAR OSNAP OTRACK LWT MODEL

status bar

**AutoCAD ни барча
УСКУНАЛАР
ПАНЕЛИ**

**Булар ёрдамида
истаган чизмани чизиш
мумкин!!!**

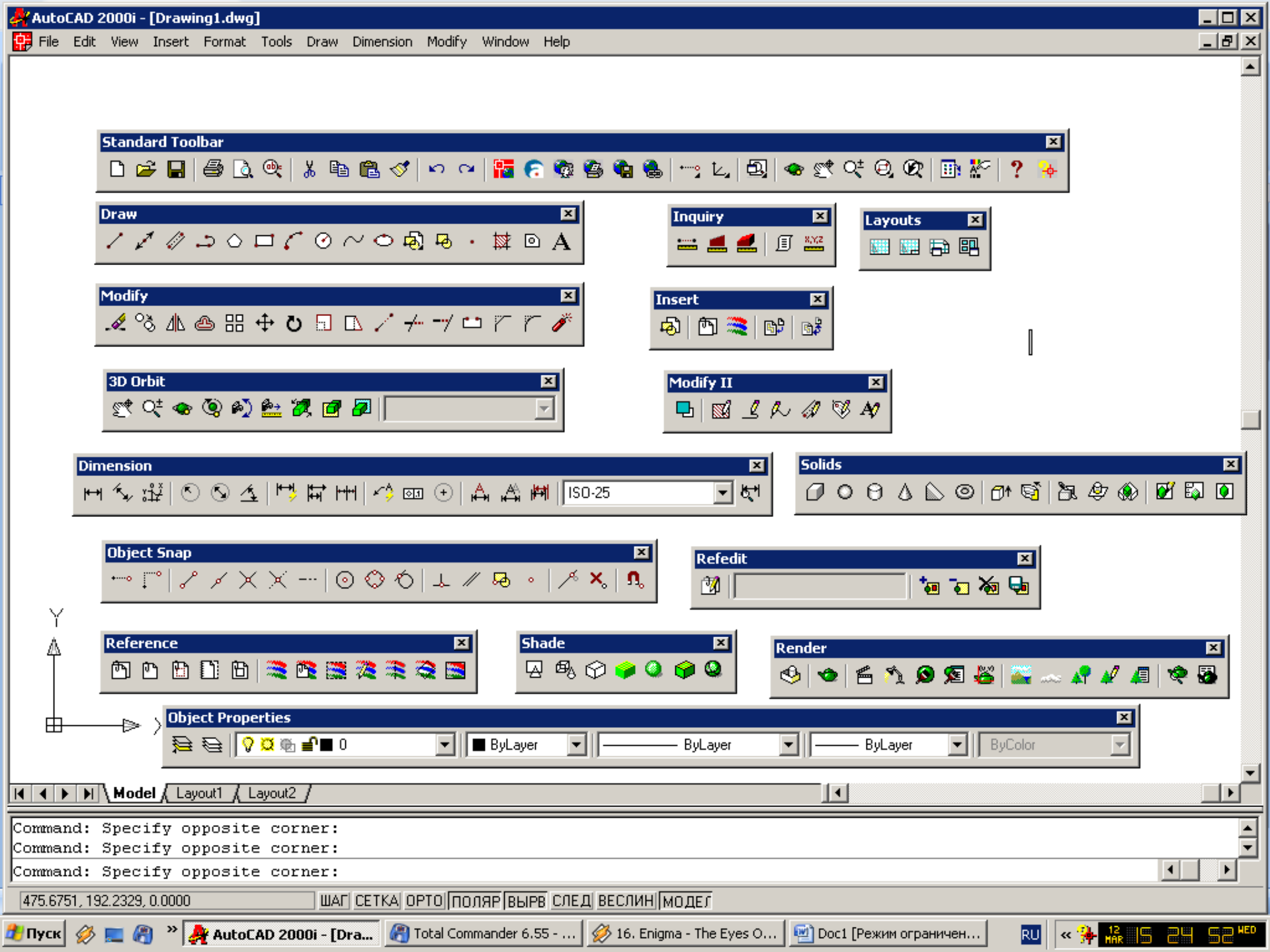

Solids Editing



Viewports



UCS



View



UCS II

Мир

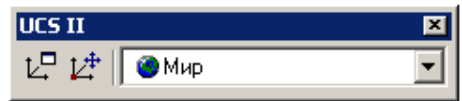

Web

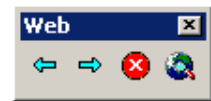

Zoom



Surfaces

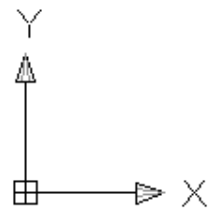



ТҰҒРИ ЧИЗИҚ (LINE)

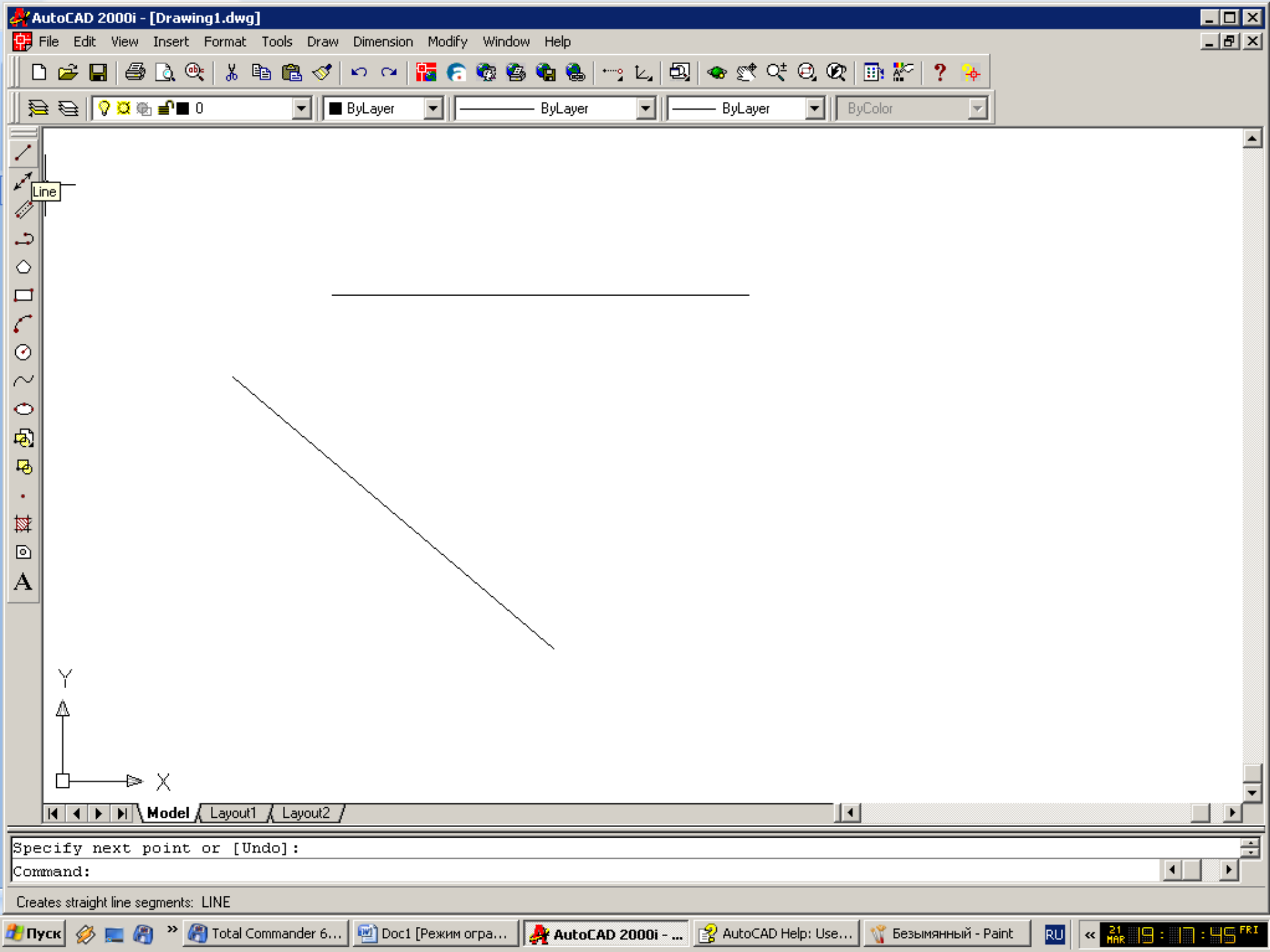

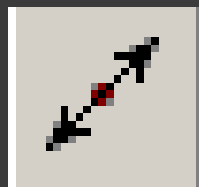

ЎҚ ЎТКАЗИШ

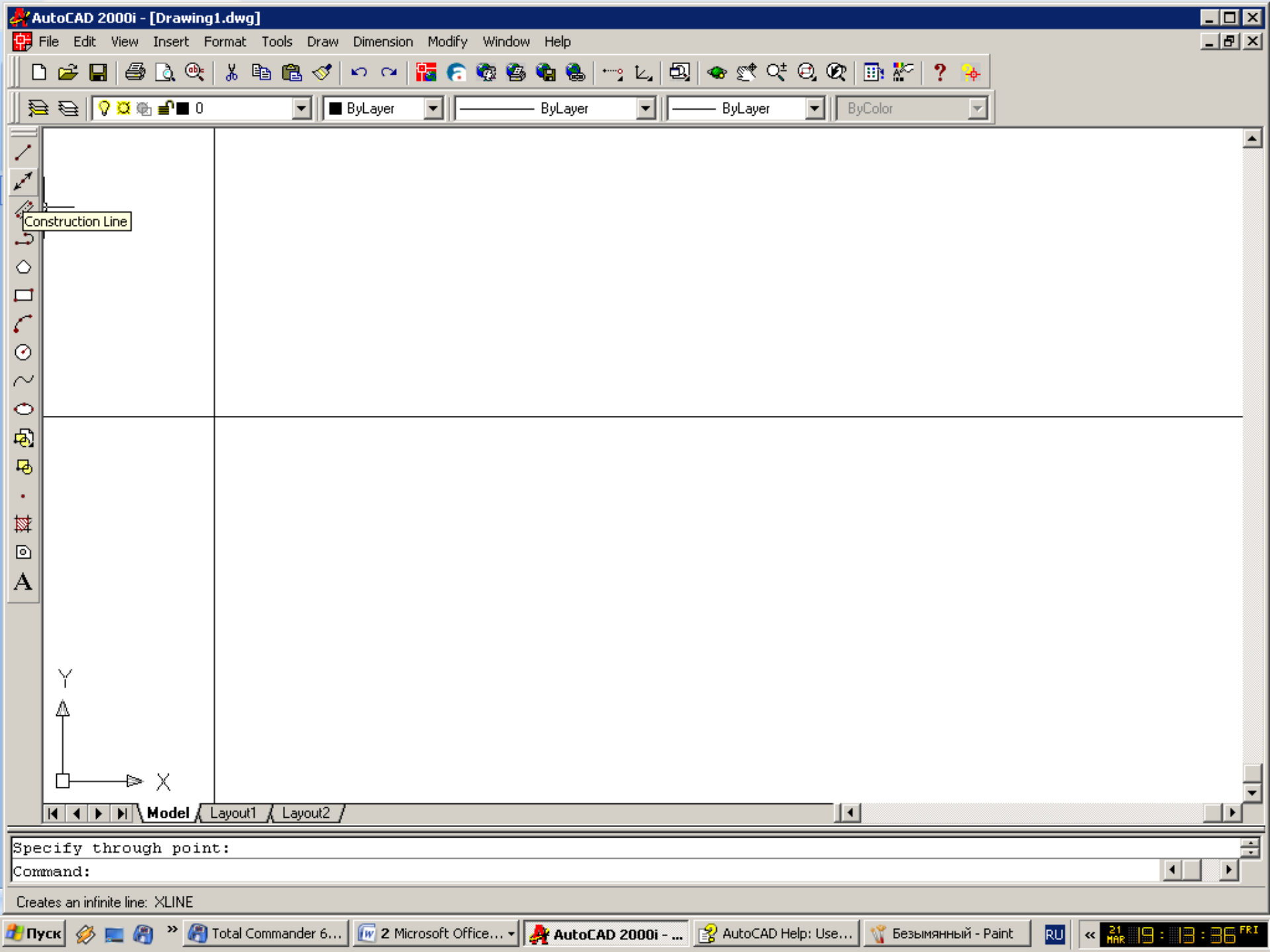

Toolbar with icons for file operations (Save, Print, Copy, Paste), editing (Undo, Redo), and drawing (Line, Circle, Arc, etc.). Below the icons are layer and color selection dropdowns: "ByLayer", "ByLayer", "ByLayer", and "ByColor".

Vertical toolbar on the left side of the drawing area, containing icons for various drawing tools such as Line, Circle, Arc, and Construction Line.

Construction Line

Specify through point:

Command:

Creates an infinite line: XLINE

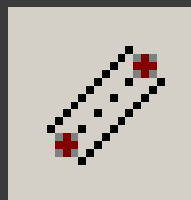

ПАРАЛЛЕЛ ЧИЗИҚЛАР

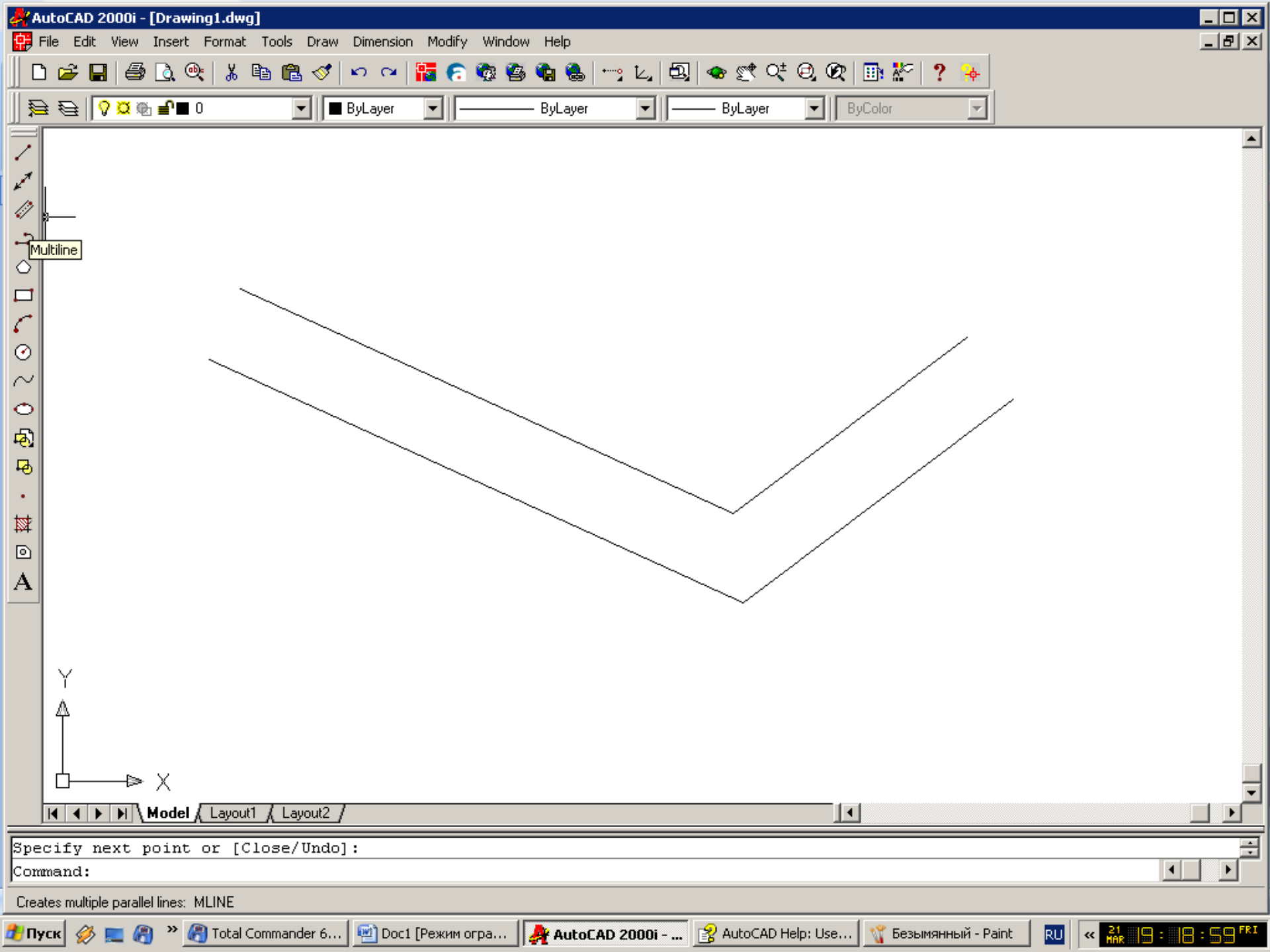

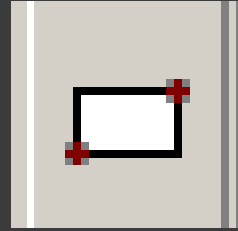

ТЎҒРИ ТЎРТБУРЧАК

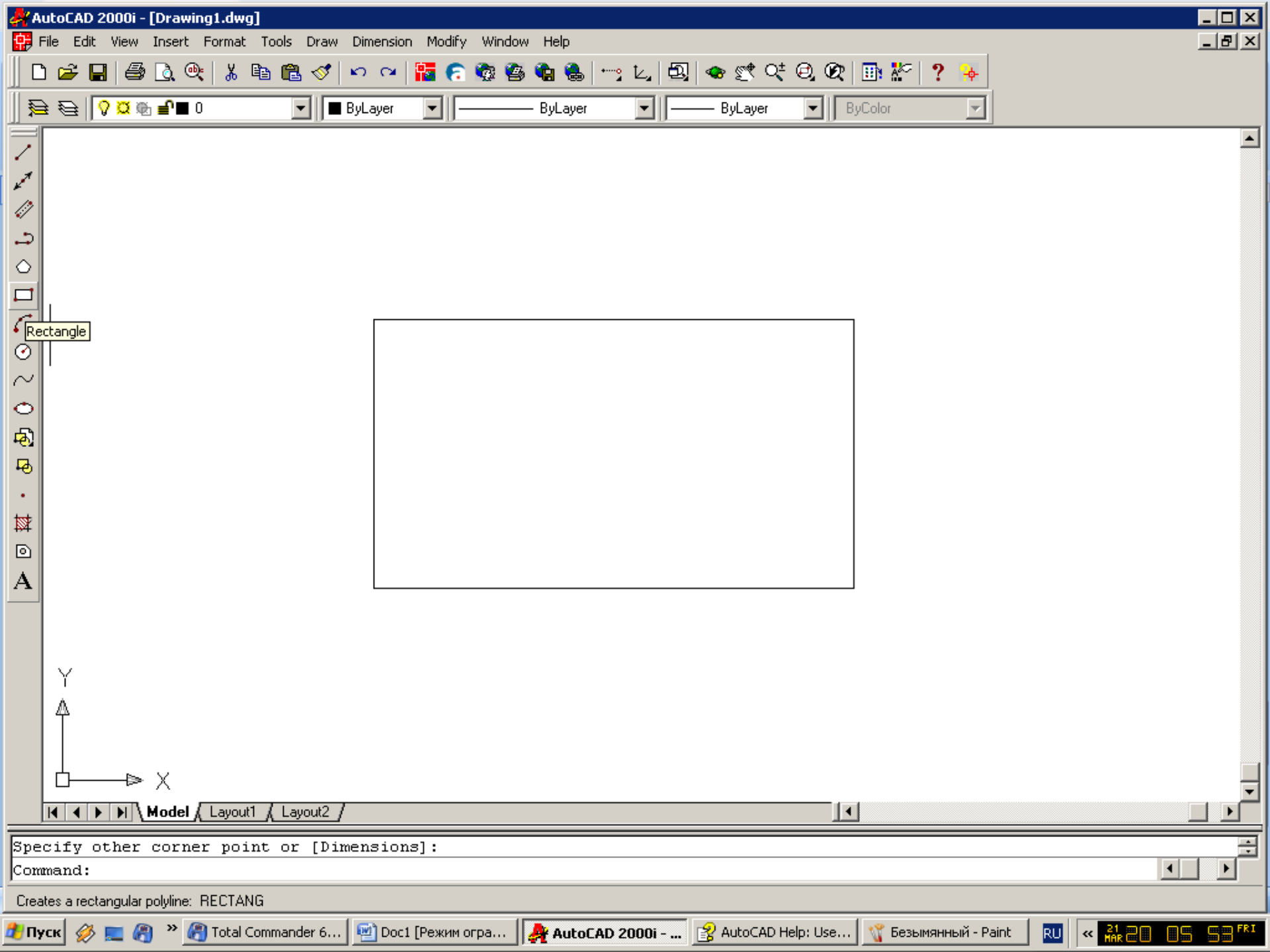

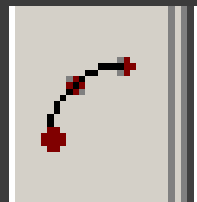

ЯРИМ АЙЛАНА

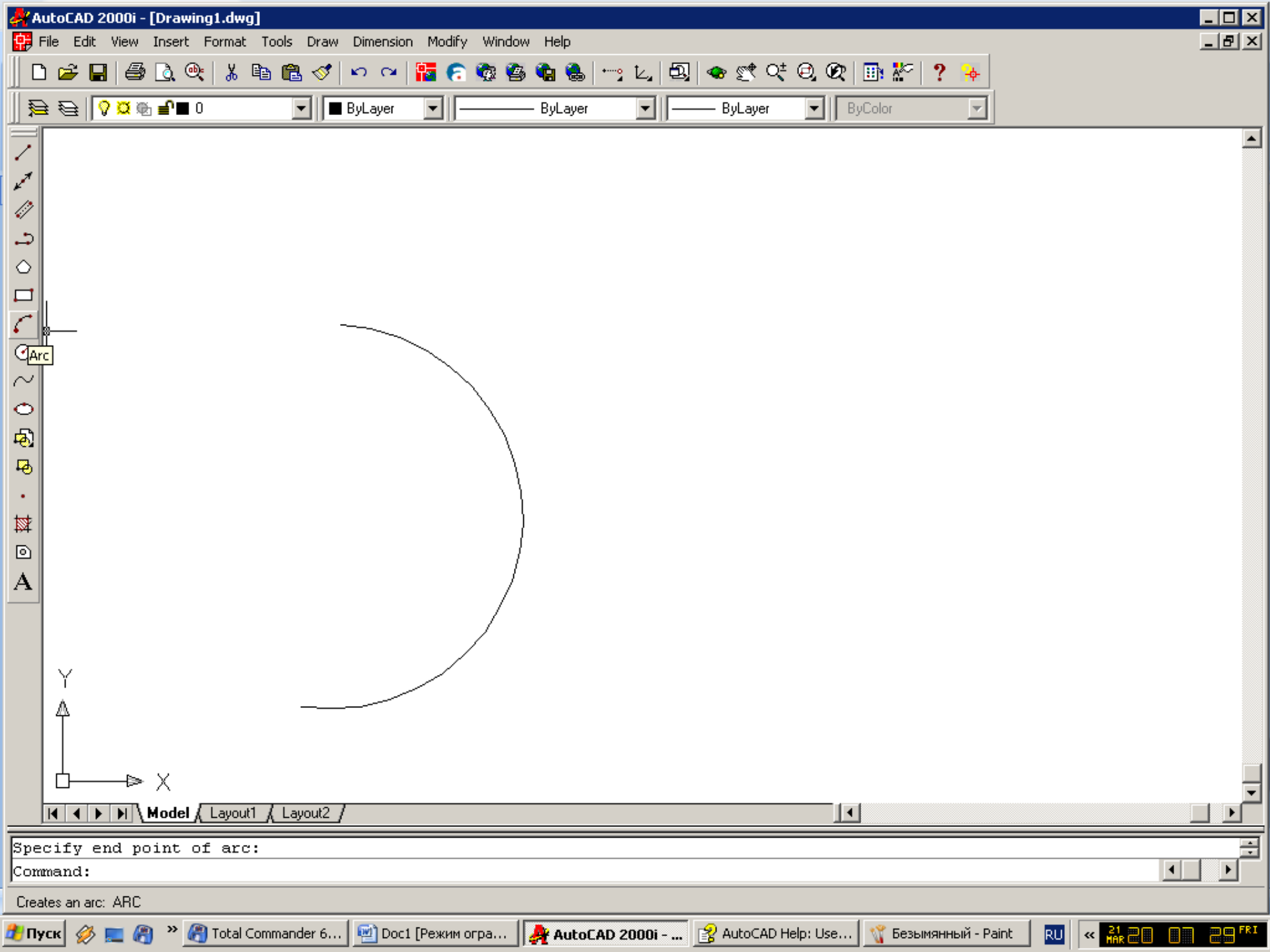

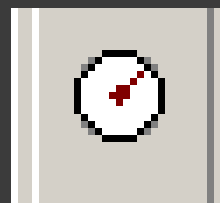

АЙЛАНА

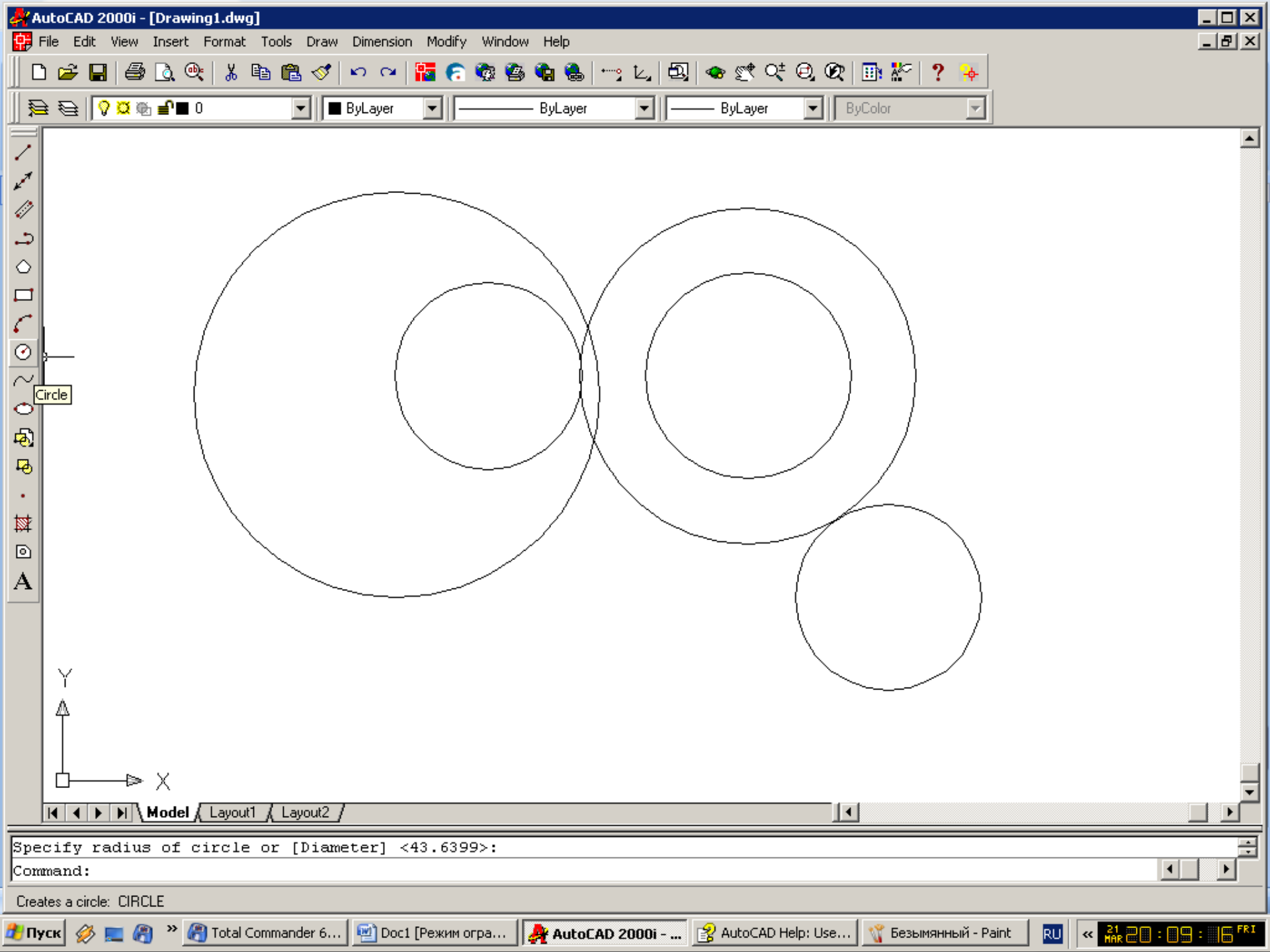

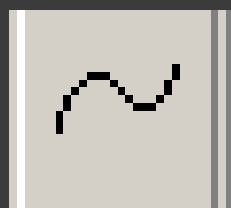

ЭГРИ ЧИЗИК

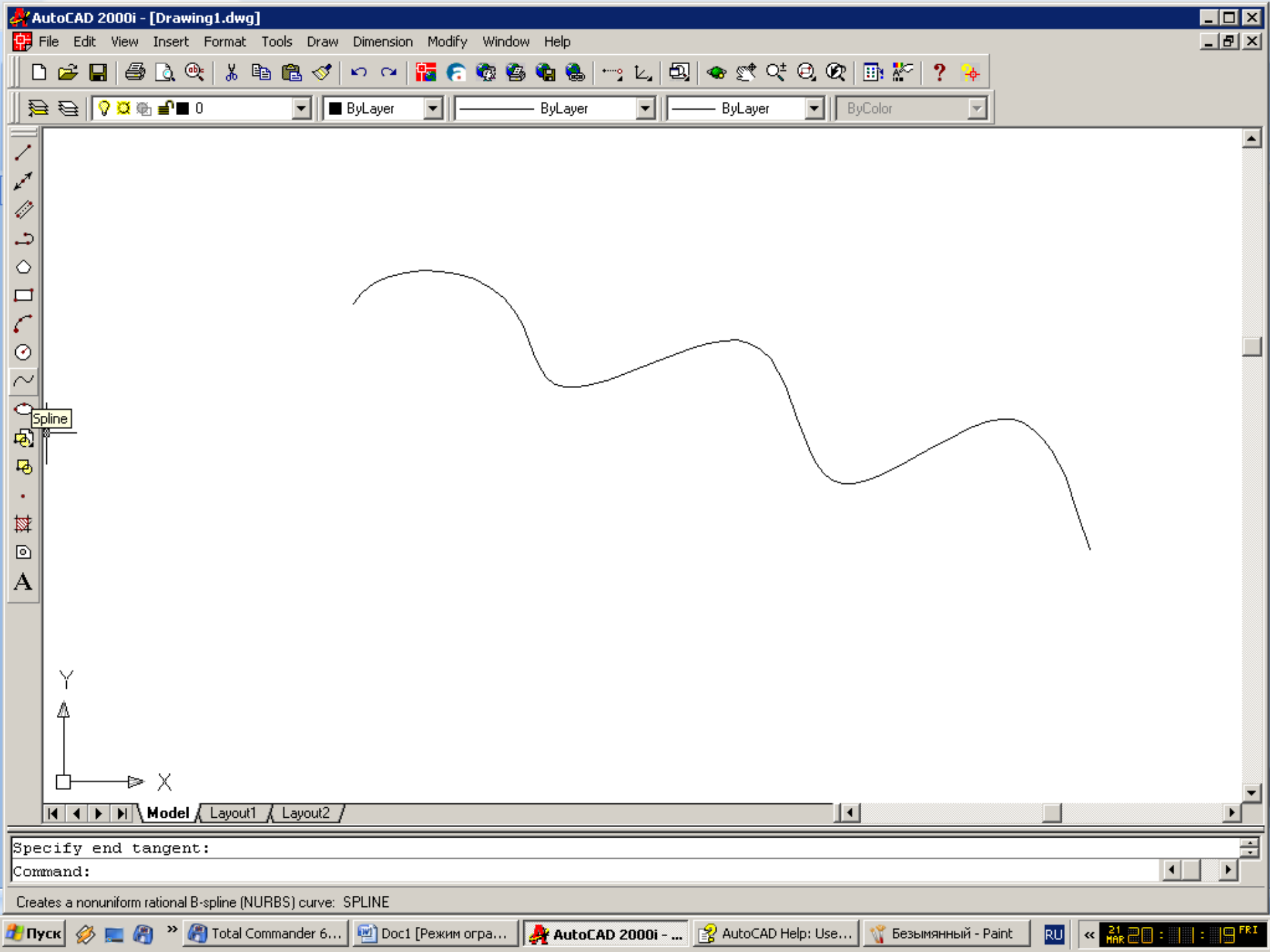

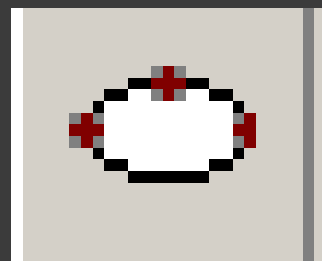

ЭЛЛИПС

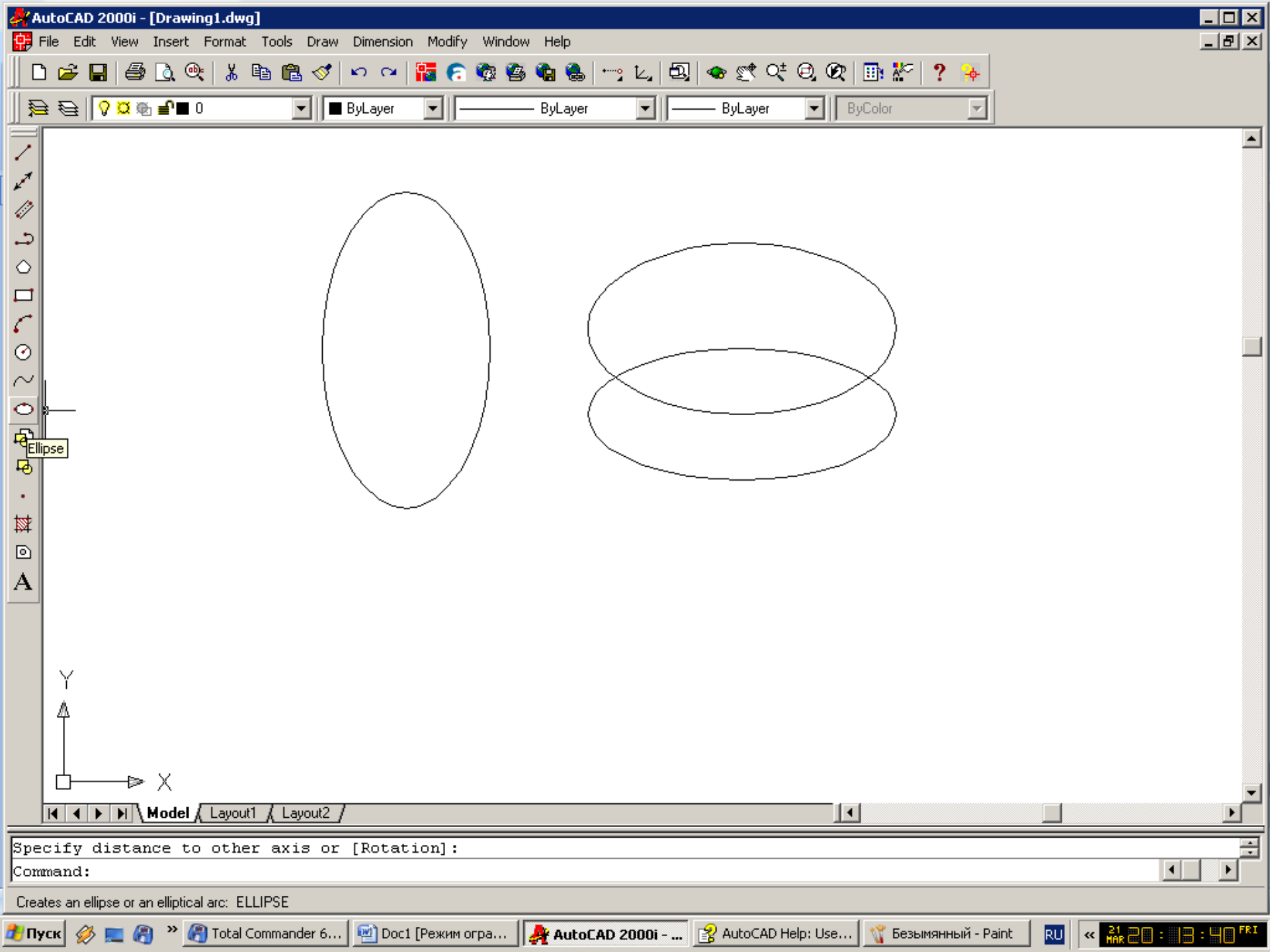

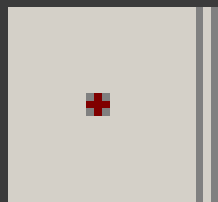

HYŠTA

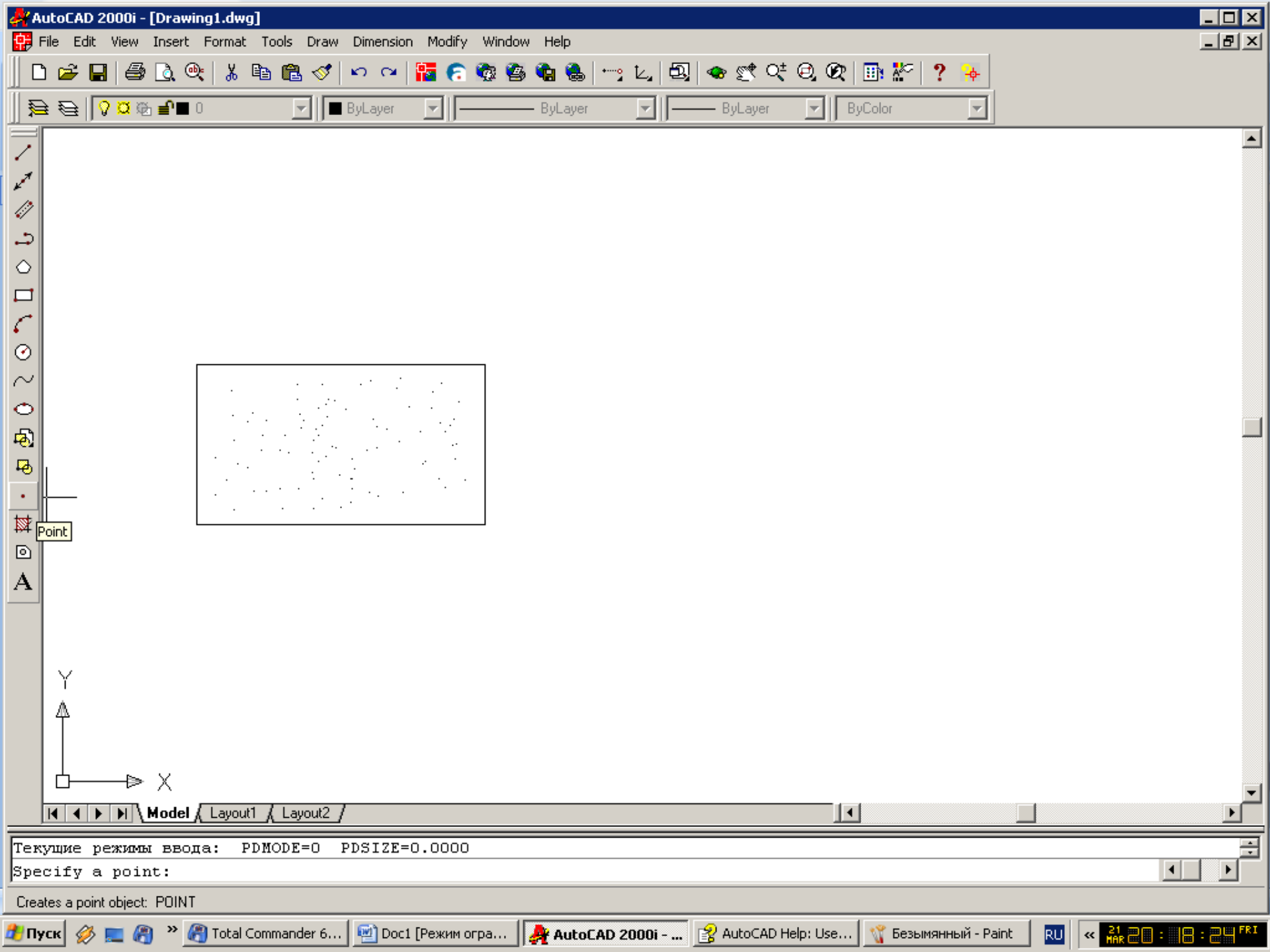

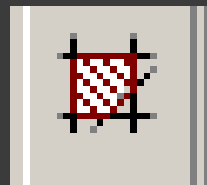

БЕЛГИЛАНГАН ШАКЛНИ ШТРИХЛАШ

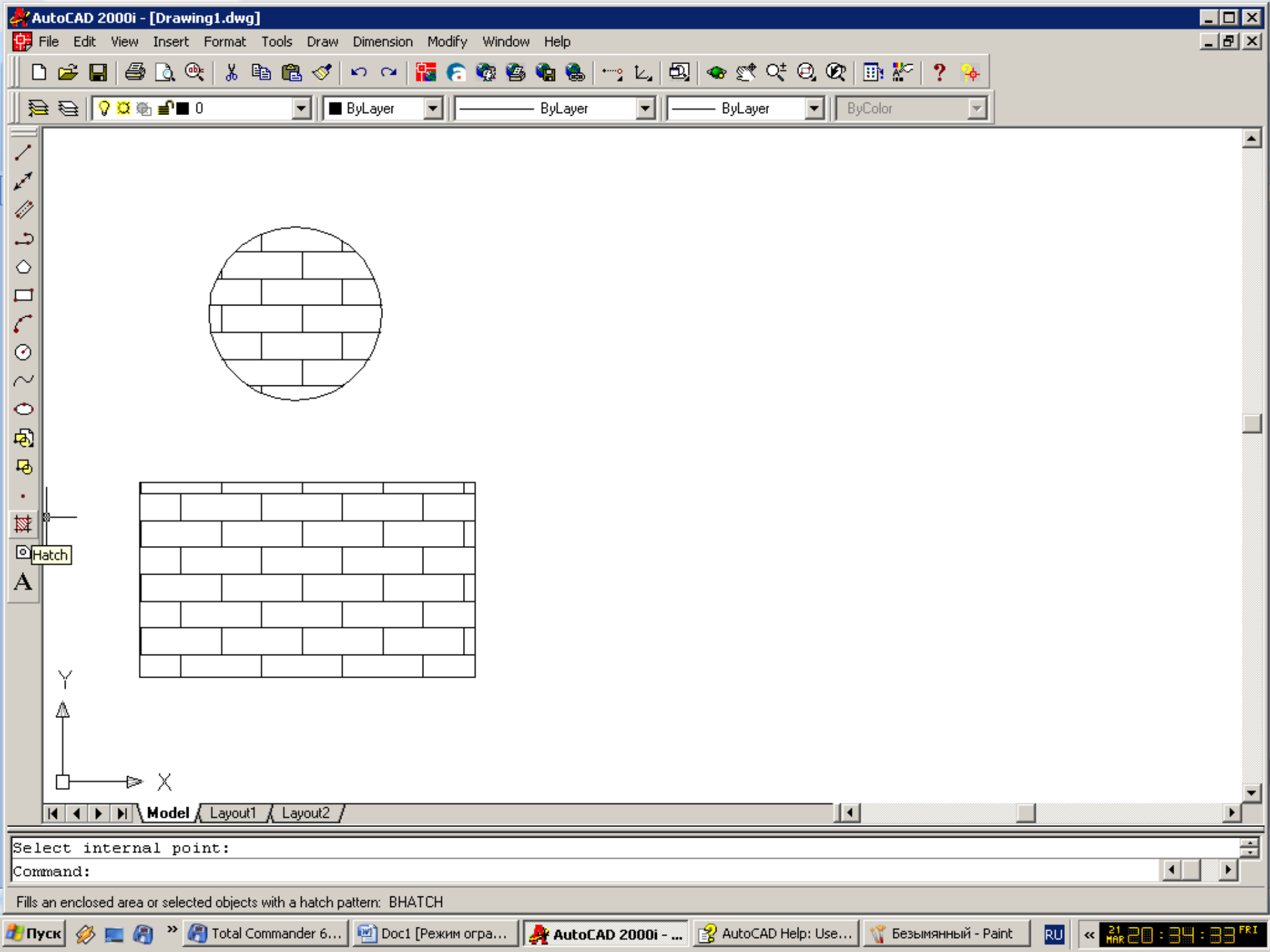

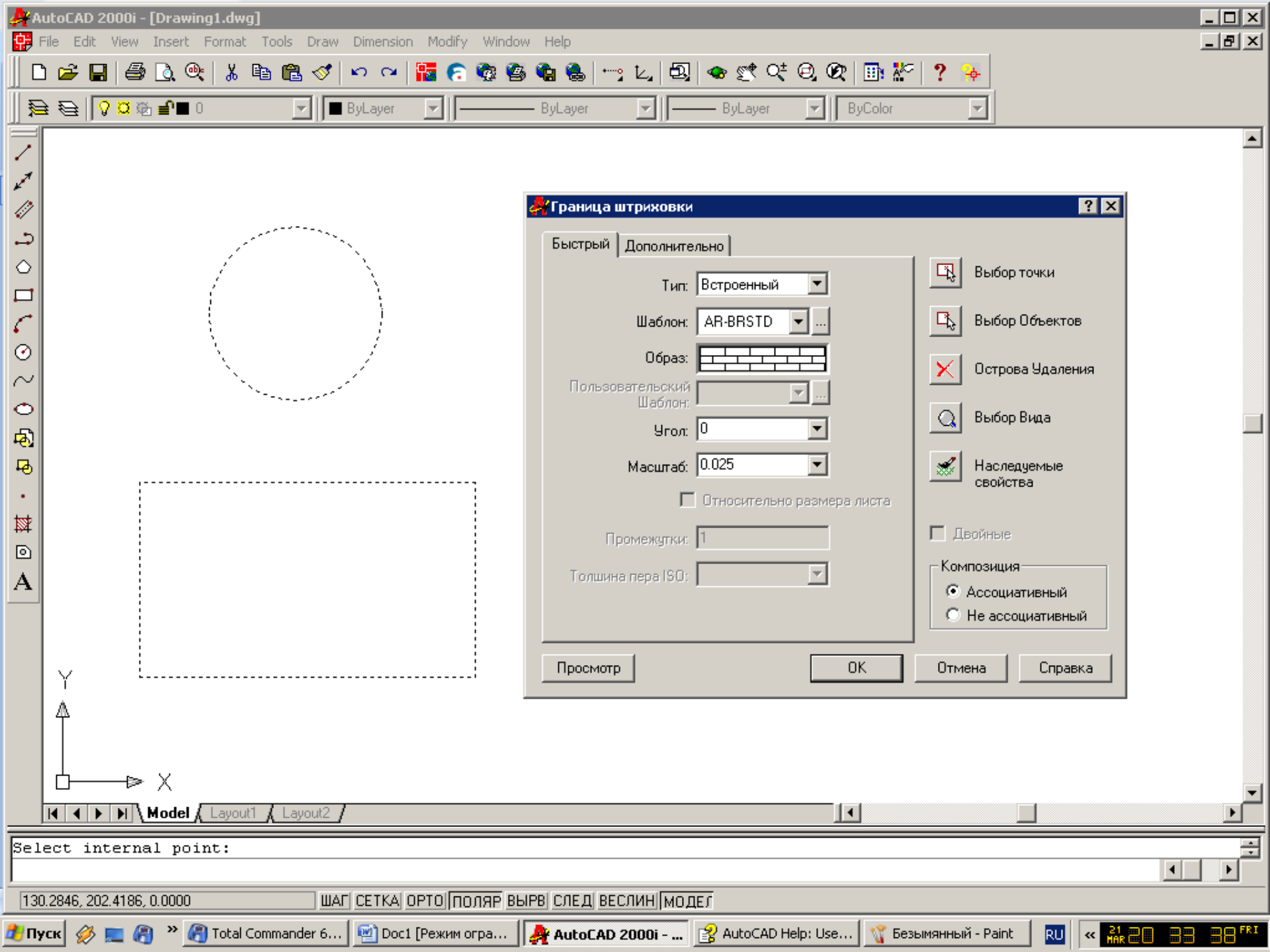

Граница штриховки

Быстрый | Дополнительно

Тип: Встроенный

Шаблон: AR-BRSTD

Образ: [Grid Pattern]

Пользовательский Шаблон: [None]

Угол: 0

Масштаб: 0.025

Относительно размера листа

Промежутки: 1

Толщина пера ISO: [None]

Выбор точки

Выбор Объектов

Острова Удаления

Выбор Вида

Наследуемые свойства

Двойные

Композиция

Ассоциативный

Не ассоциативный

Просмотр | OK | Отмена | Справка

Select internal point:

130.2846, 202.4186, 0.0000 | ШАГ СЕТКА | ОРТО | ПОЛЯР | ВЫРВ | СЛЕД | ВЕСЛИН | МОДЕЛ

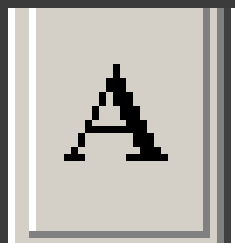

ЁЗУВ ЁЗИШ

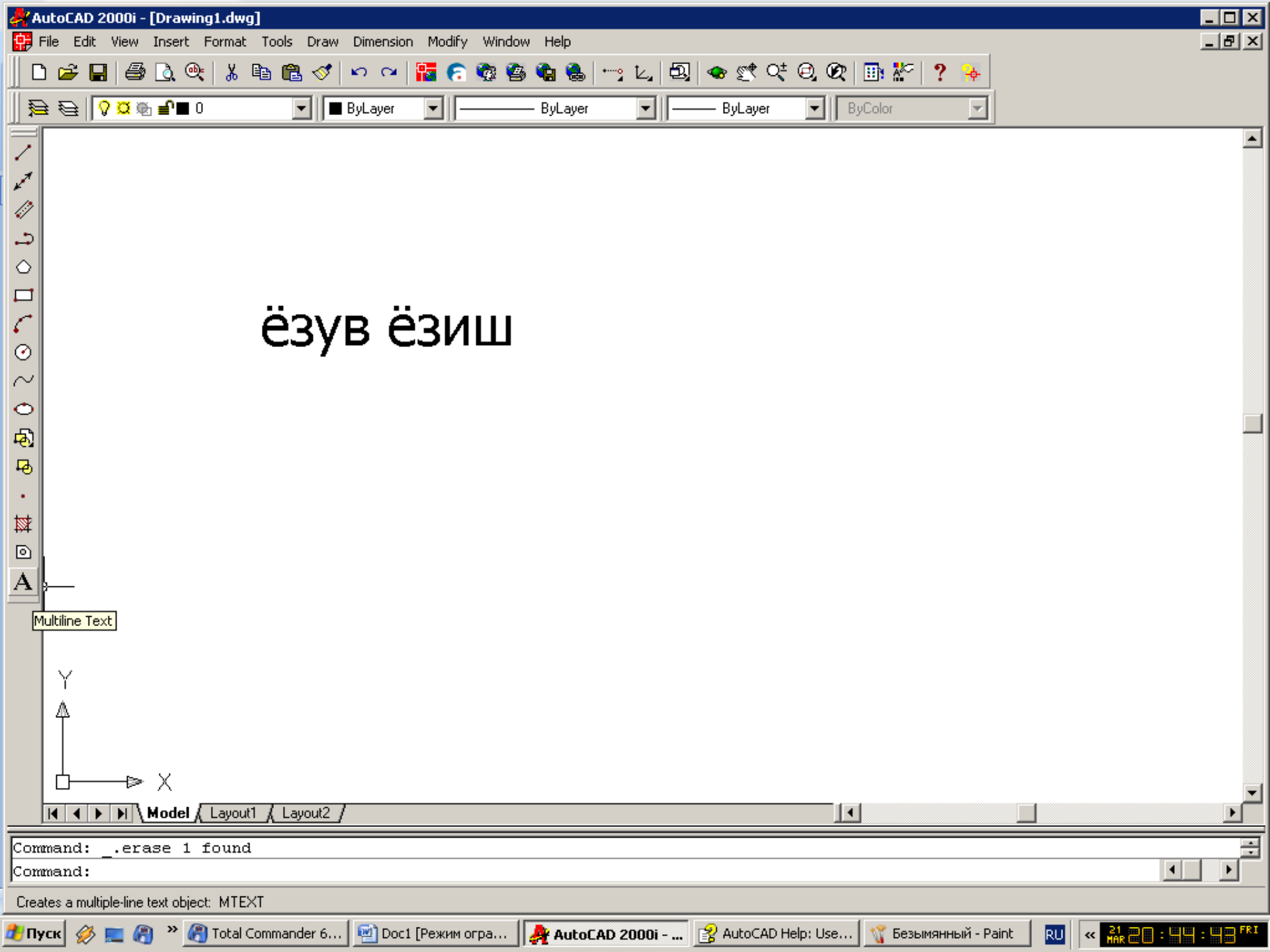

ёзув ёзиш

Multiline Text

Command: _erase 1 found

Command:

Creates a multiple-line text object: MTEXT

УСКУНАЛАР ПАНЕЛИГА ЯНГИ УСКУНАЛАРНИ ЏИШИШ

Унинг учун сичшонни
УСКУНАЛАР ПАНЕЛИНИ
УСТИГА ОЛИБ БОРИЛИБ, ЯНГИ
ТУГМАСИНИ БОСИЛАДИ ВА
ТАНЛАНАДИ

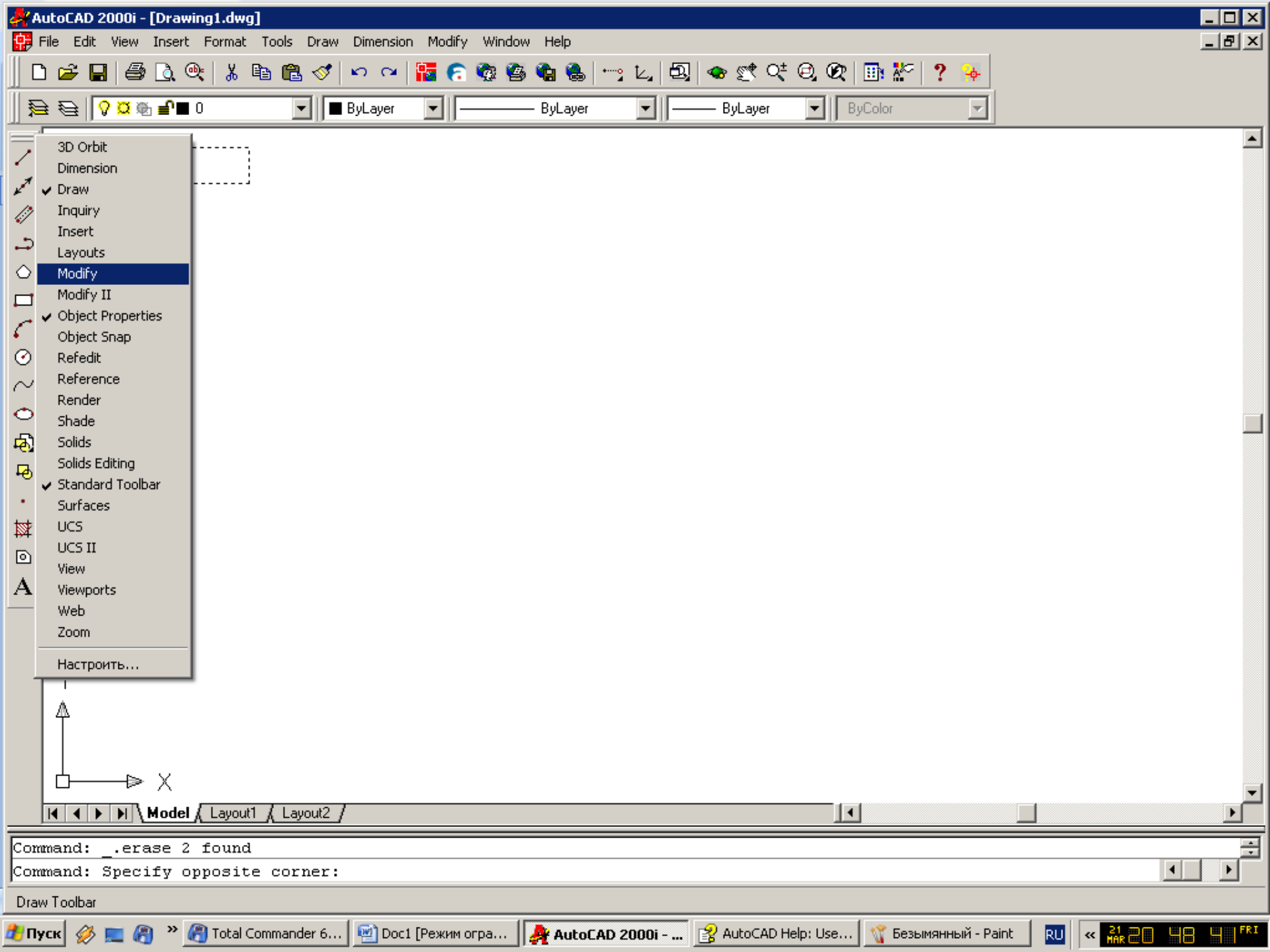

Standard toolbar icons for drawing and editing. Below the icons are three dropdown menus for layer and color settings, all currently set to 'ByLayer'.

- 3D Orbit
- Dimension
- Draw
- Inquiry
- Insert
- Layouts
- Modify
- Modify II
- Object Properties
- Object Snap
- Refedit
- Reference
- Render
- Shade
- Solids
- Solids Editing
- Standard Toolbar
- Surfaces
- UCS
- UCS II
- View
- Viewports
- Web
- Zoom
- Настроить...

Command: .erase 2 found
Command: Specify opposite corner:

Draw Toolbar



іЧИРЪИЧ

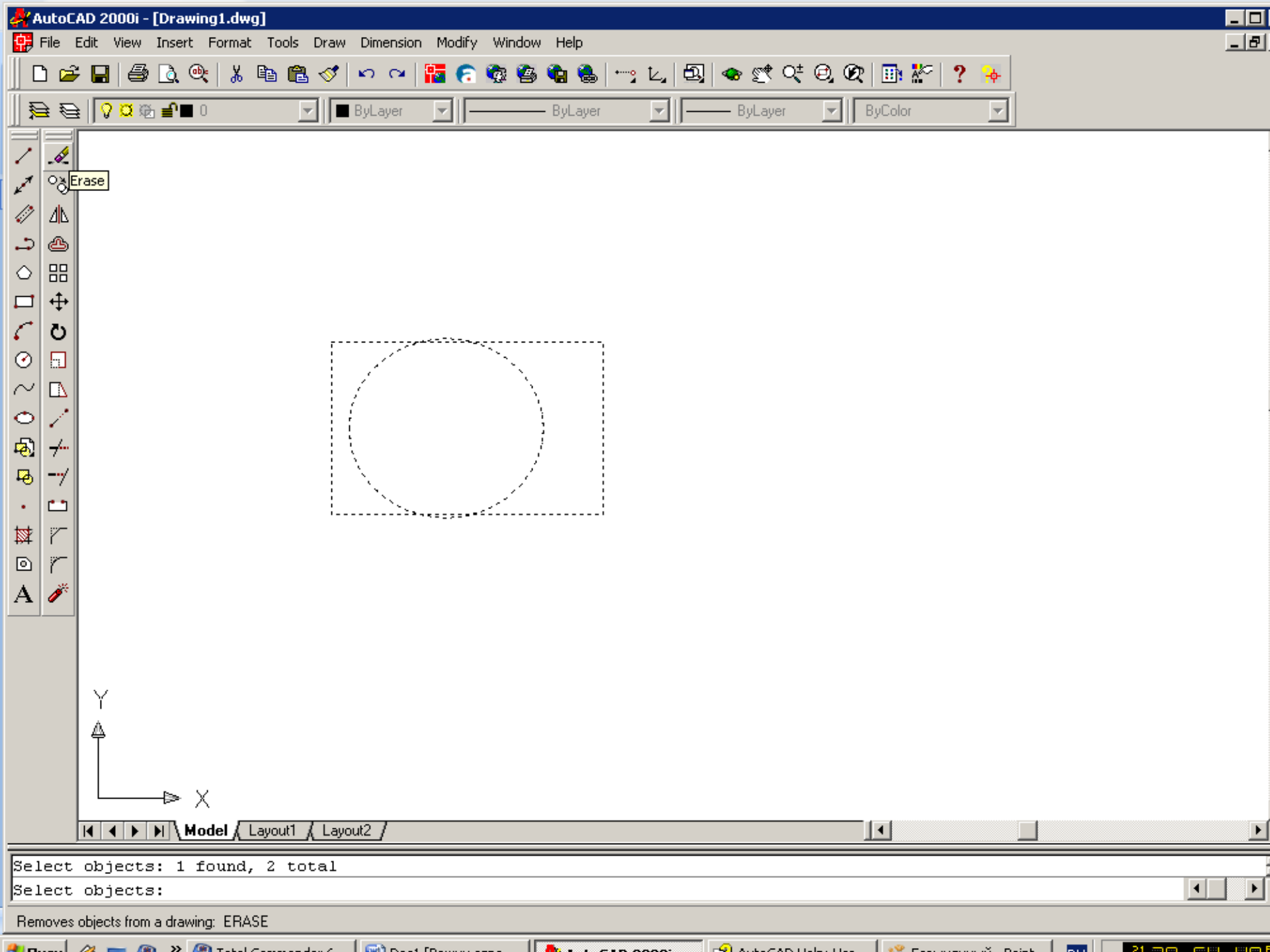

Property boxes for layer and color settings, including "ByLayer" and "ByColor" dropdown menus.

Vertical toolbar containing various drawing tools such as line, circle, and eraser.

Main drawing area showing a circle and a dashed rectangular bounding box around it.

Select objects: 1 found, 2 total
Select objects:

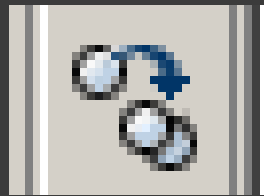

ШАКЛНИ КІЧИРИШ

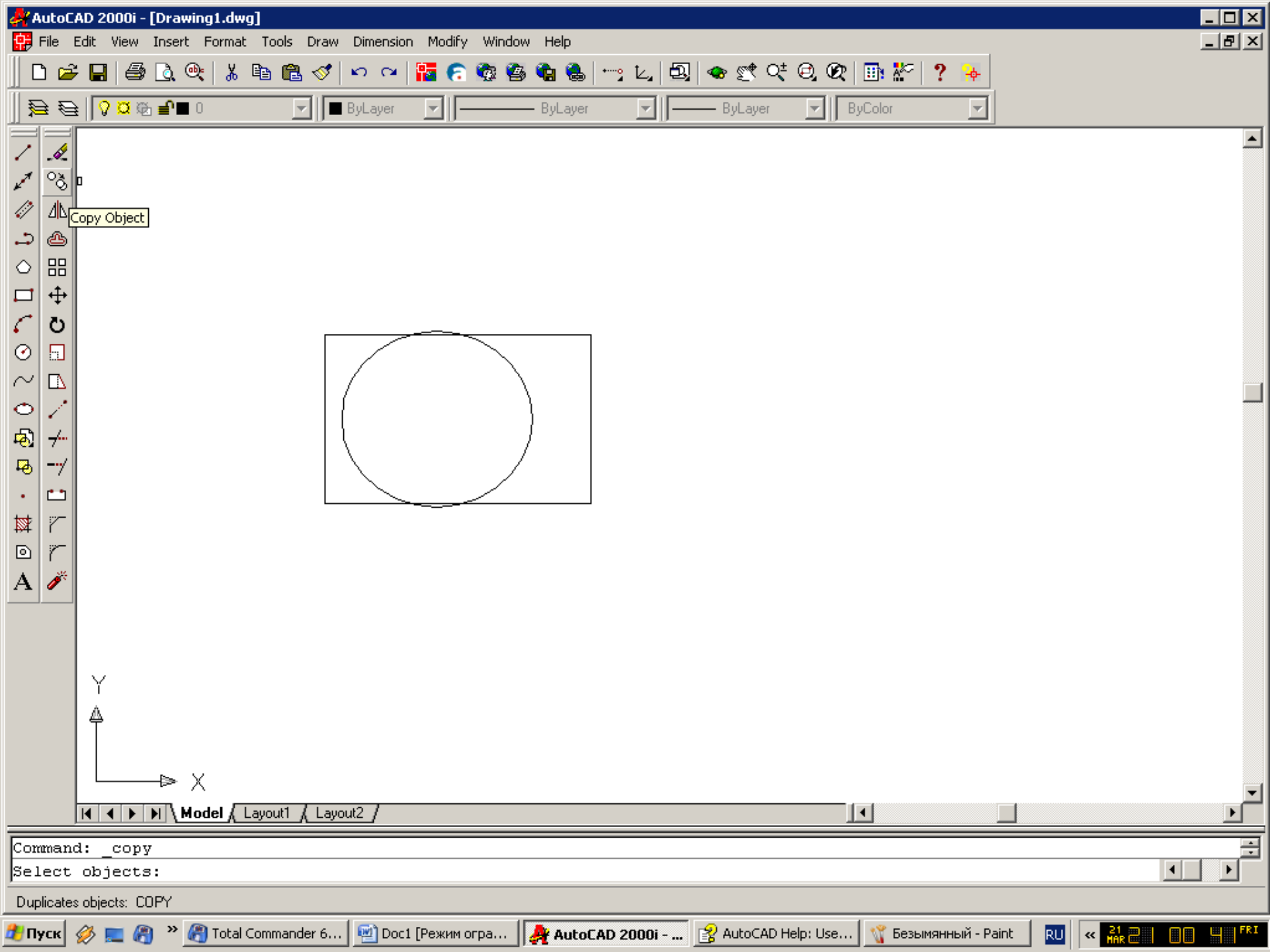

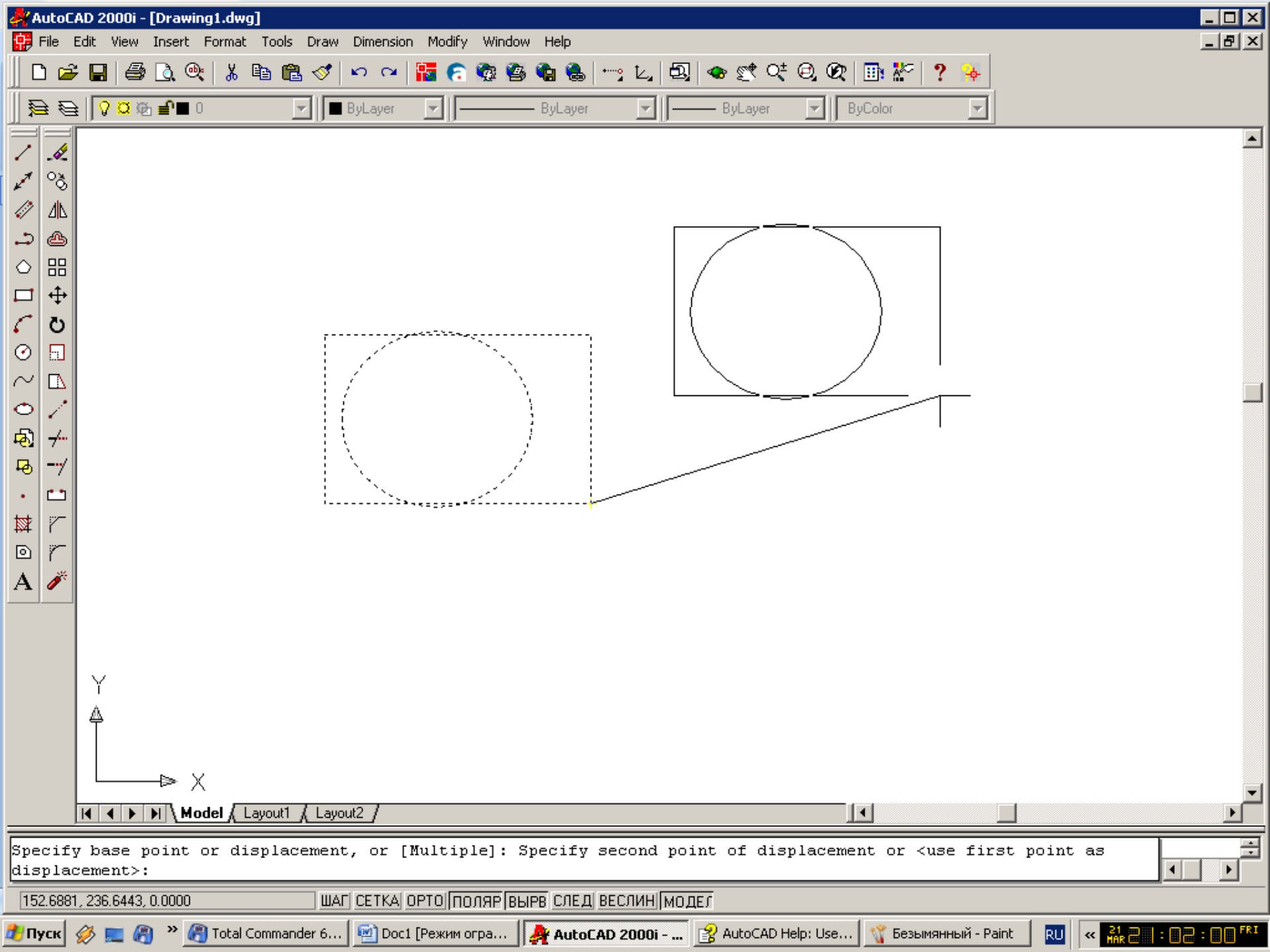

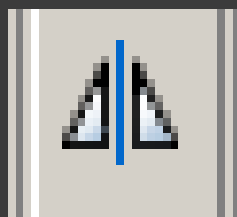

БЕРИЛГАН ШАКЛНИ
БЕЛГИЛАНГАН РАДИУСЛИ
АЙЛАНА БЇЙЛАБ
ЖОЙЛАШТИРИШ

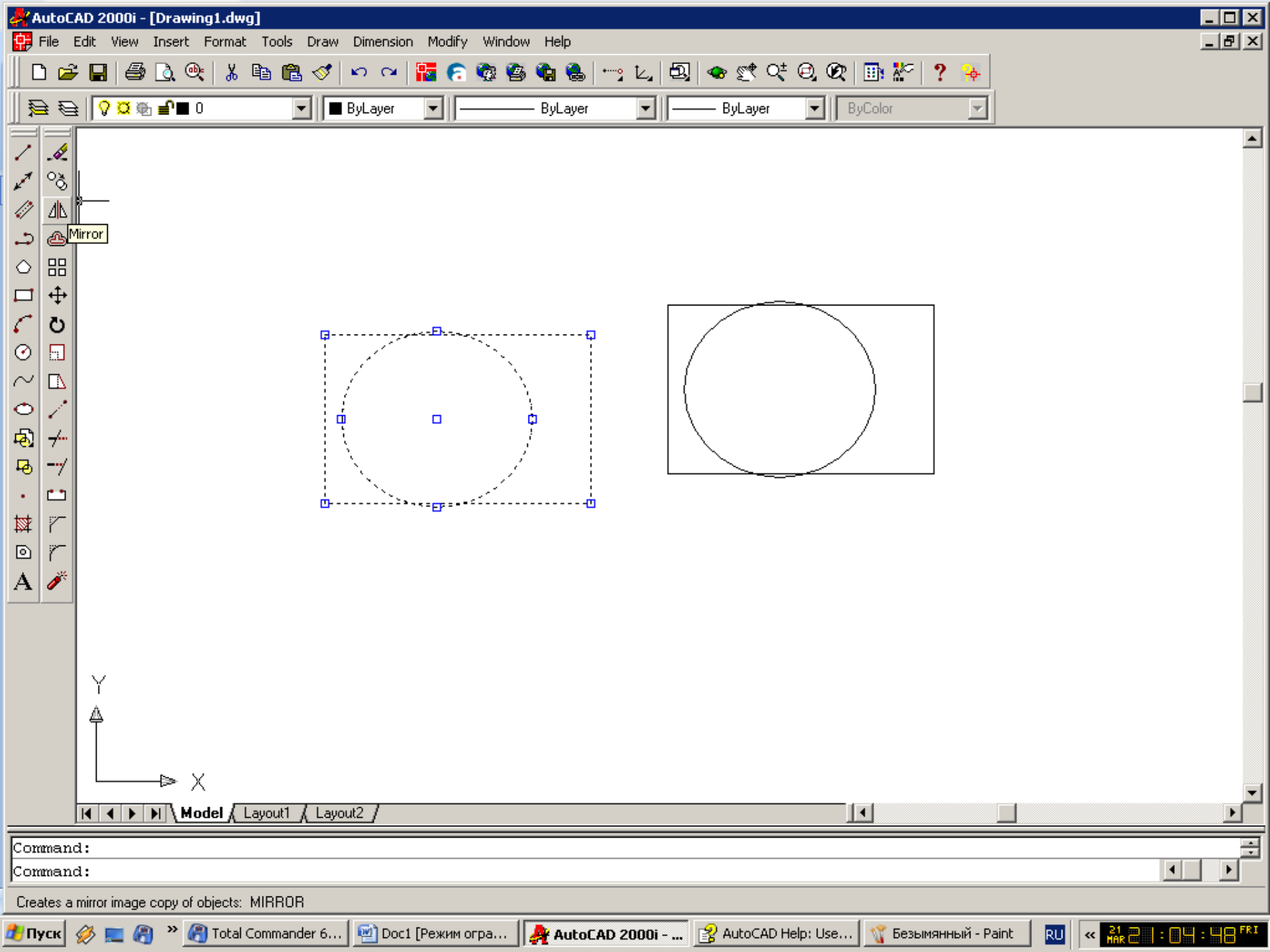

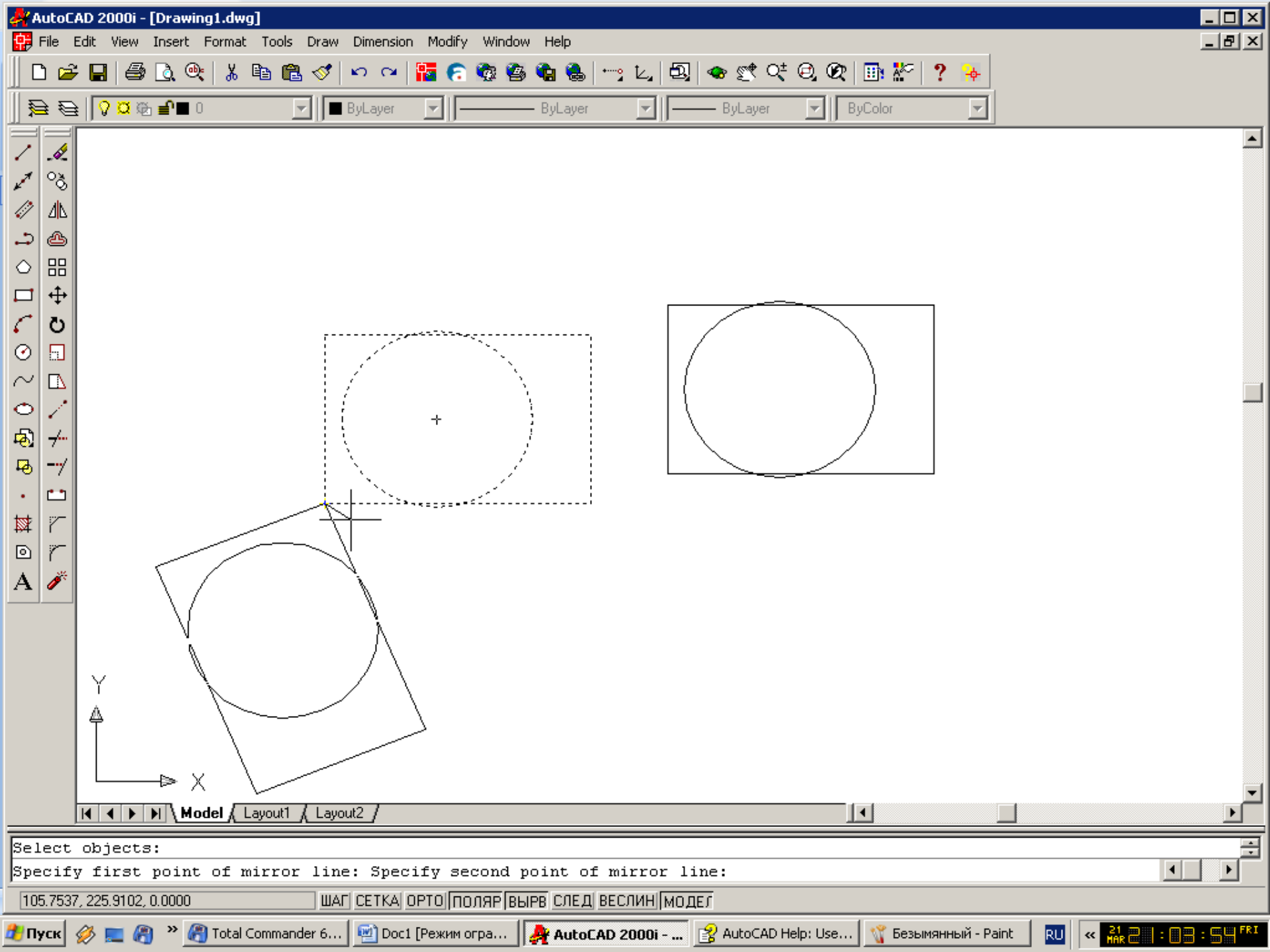

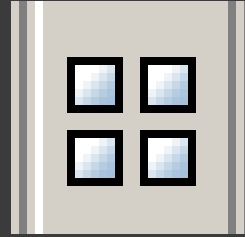

ШАКЛНИ БИР ВАЏТНИ
ЇЗИДА 4X4 МАРТТА
КЇПАЙТИРИШ

Toolbar with icons for file operations, editing, and drawing. Below the toolbar are several dropdown menus for layer and color settings, all currently set to 'ByLayer' or 'ByColor'.

Main drawing area showing a dashed circle with eight blue square handles for manipulation. A tooltip labeled 'Array' is visible over the left-hand toolbar. In the bottom-left corner, a coordinate system is shown with 'Y' and 'X' axes.

Command: Specify opposite corner:
Command:

Creates multiple copies of objects in a pattern: ARRAY



Array [?] [X]

Rectangular Array Polar Array Select objects

2 objects selected

Rows: Columns:

Offset distance and direction

Row offset:

Column offset:

Angle of array:

Tip
By default, if the row offset is negative, rows are added downward. If the column offset is negative, columns are added to the left.

OK
Cancel
Preview <
Help

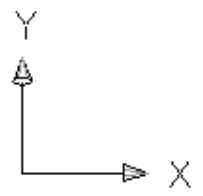
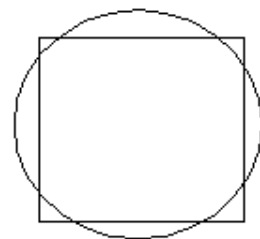

Select objects:

Toolbar with icons for file operations, editing, and drawing. Below the toolbar are three dropdown menus for layer and color settings, all currently set to 'ByLayer' or 'ByColor'.

Main drawing area showing a grid of 10x10 squares with overlapping circles. The 'Array' tool is highlighted in the left toolbar. A coordinate system with X and Y axes is visible in the bottom-left corner of the drawing area.

Command: _array 2 found
Command:

Creates multiple copies of objects in a pattern: ARRAY

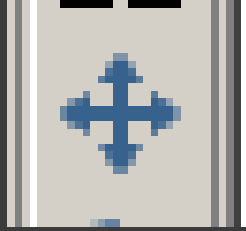

ШАКЛНИ БИР ЕРДАН
ОЛИБ БОШЅА ЕРГА
ЅїЙИШ

Toolbar with icons for file operations, editing, and drawing. Below the icons are several dropdown menus for layer and color settings, currently set to 'ByLayer'.

Main drawing area showing a dashed circle with eight blue square handles for moving. A 'Move' tooltip is visible over the left toolbar. A coordinate system with X and Y axes is shown in the bottom-left corner. The bottom status bar shows 'Model', 'Layout1', and 'Layout2' tabs.

Command:
Command:

Displaces objects a specified distance in a specified direction: MOVE

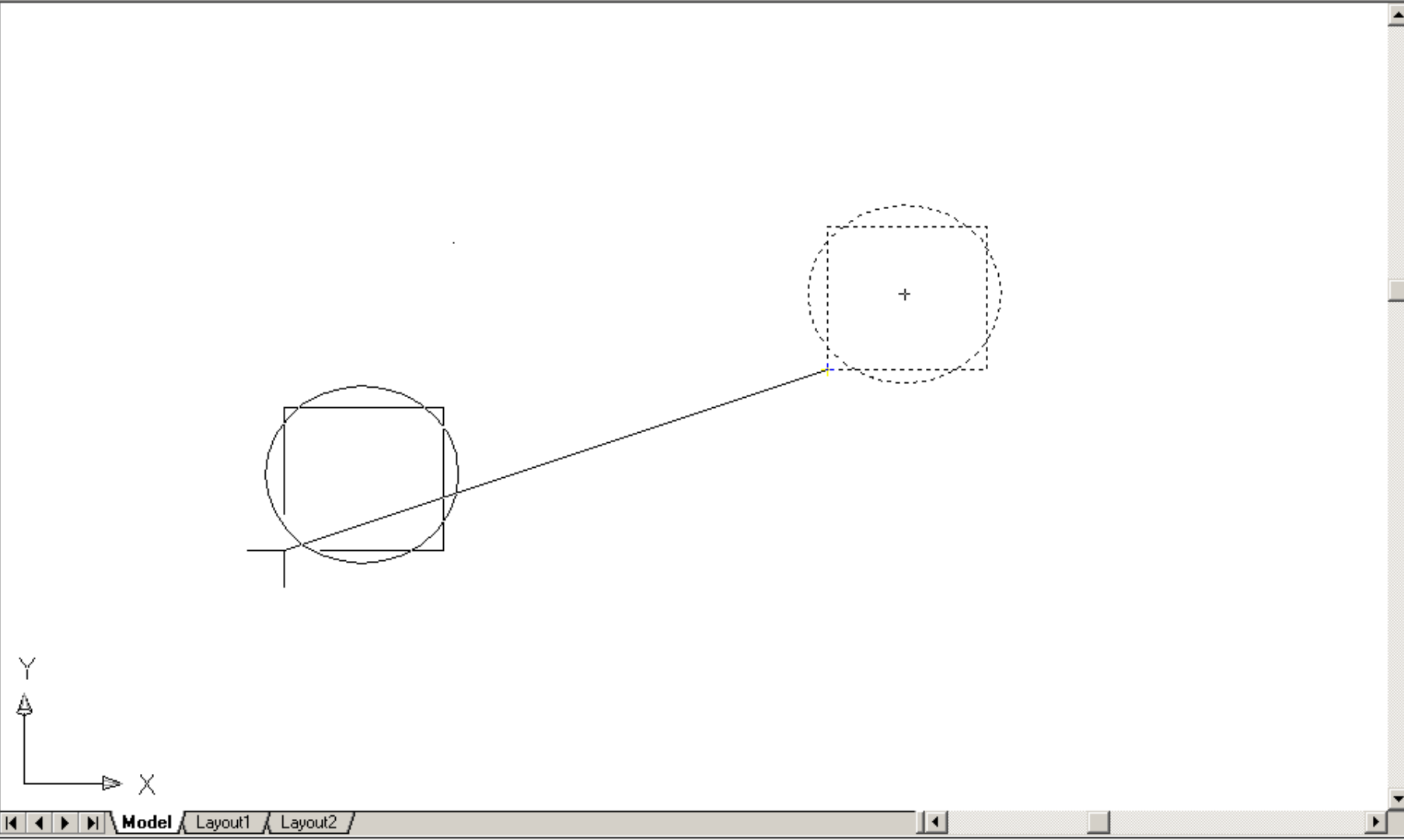

Select objects:
Specify base point or displacement: Specify second point of displacement or <use first point as displacement>:

92.6955, 216.7705, 0.0000 ШАГ СЕТКА ОРТО ПОЛЯР ВЫРВ СЛЕД ВЕСЛИН МОДЕЛ

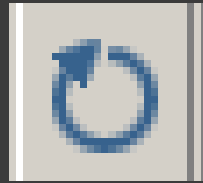

ШАКЛНИ ОНИЙ НУЏТАСИ БЇЙЛАБ АЙЛАНТИРИШ

Toolbar with icons for File, Edit, View, Insert, Format, Tools, Draw, Dimension, Modify, Window, Help. Below the toolbar are property settings: **ByLayer**, **ByLayer**, **ByLayer**, **ByColor**.

Rotate

Model | Layout1 | Layout2

Command: Specify opposite corner:
Command:

Rotates objects about a base point: ROTATE

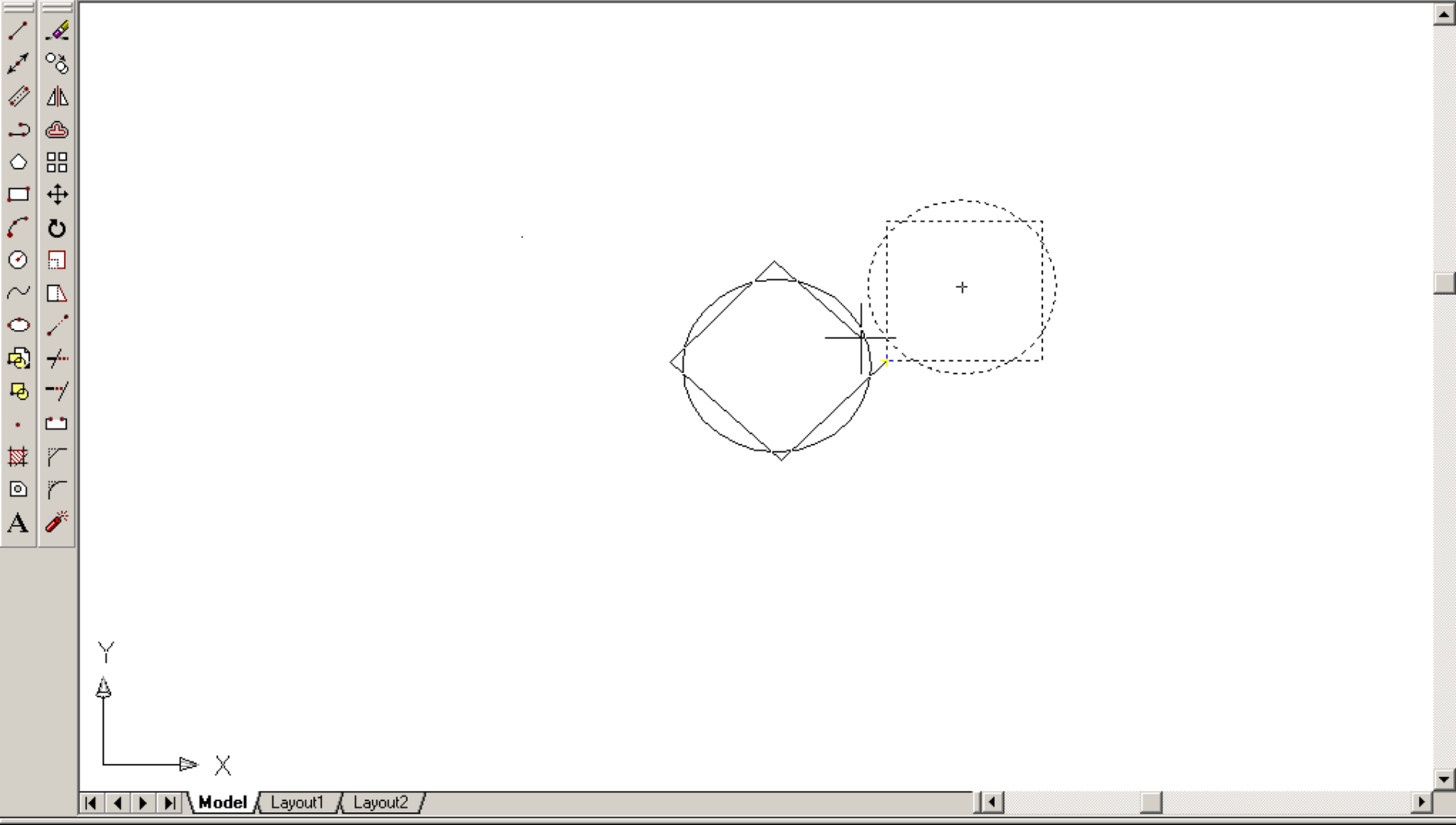

Specify base point:
Specify rotation angle or [Reference]:

142.5219, 238.1327, 0.0000 ШАГ СЕТКА ОРТО ПОЛЯР ВЫРВ СЛЕД ВЕСЛИН МОДЕЛ

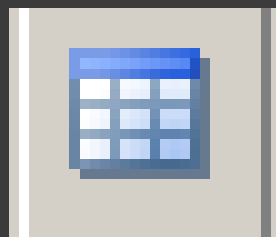

ЖАДВАЛ ТУЗИШ

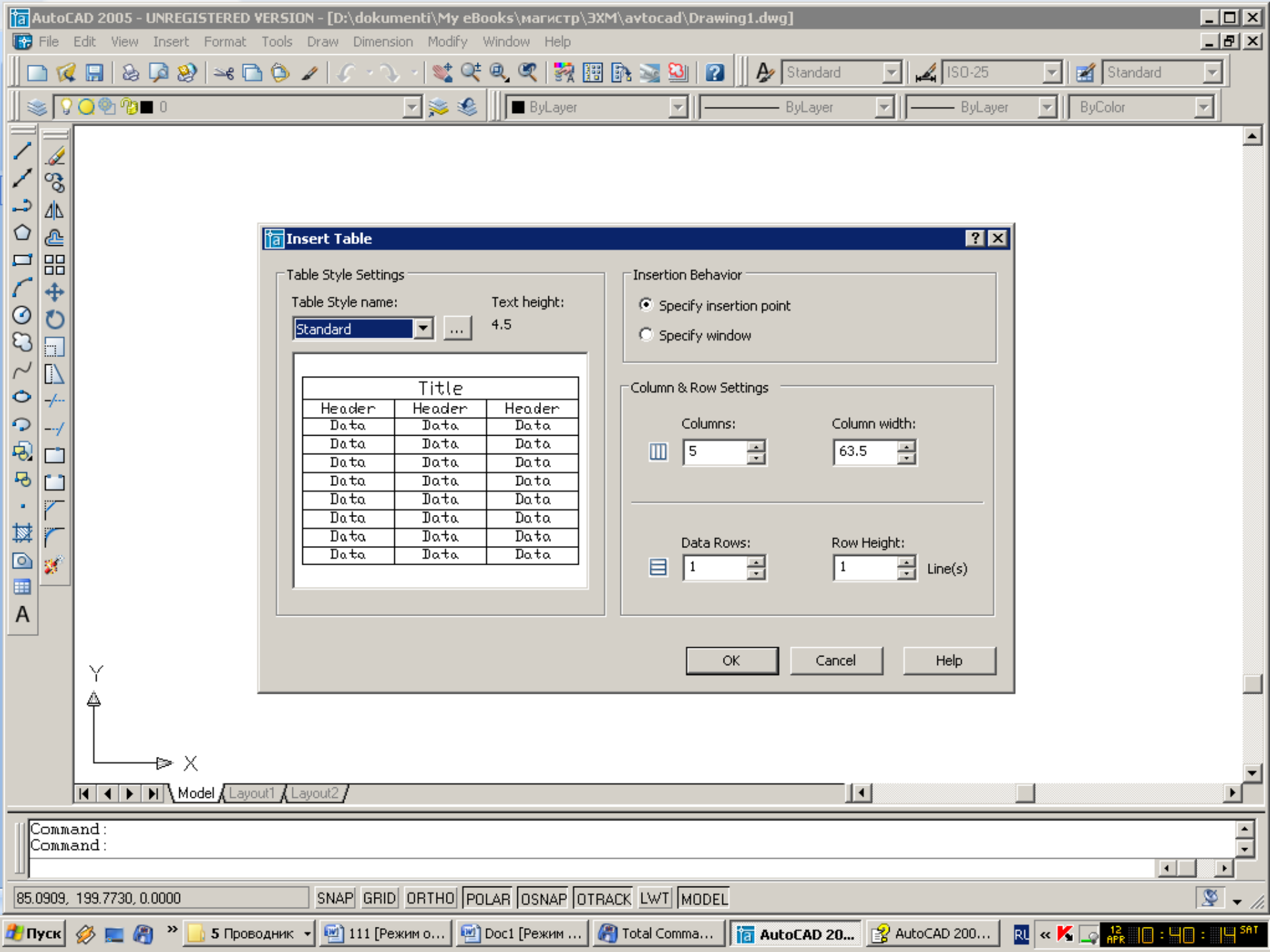

Insert Table

Table Style Settings

Table Style name: Standard Text height: 4.5

Title		
Header	Header	Header
Data	Data	Data
Data	Data	Data
Data	Data	Data
Data	Data	Data
Data	Data	Data
Data	Data	Data
Data	Data	Data
Data	Data	Data
Data	Data	Data

Insertion Behavior

Specify insertion point
 Specify window

Column & Row Settings

Columns: 5 Column width: 63.5

Data Rows: 1 Row Height: 1 Line(s)

OK Cancel Help

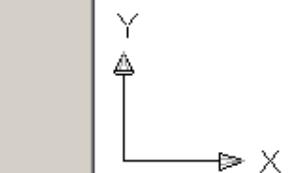

Standard ISO-25 Standard
ByLayer ByLayer ByLayer ByColor

ёзув ёзиш				

Text Formatting
Standard Arial for UzDaslbora 6 **B** *I* U OK

Command:
Command: _table
Specify insertion point:

